

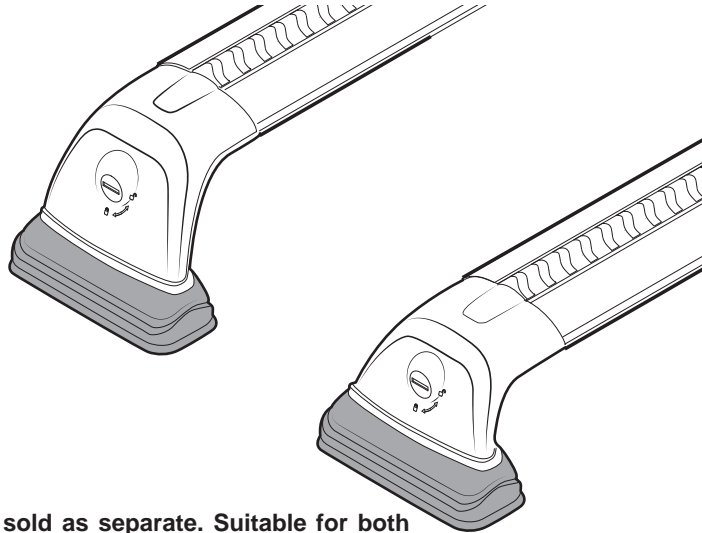

RHINO-RACK

RCP48-BK Base Kit

Important: Please read these instructions carefully prior to installation. Please refer to your fitting instruction to ensure that the roof racks are installed in the correct locations. Check the contents of kit before commencing fitment and report any discrepancies



Note: Crossbars and legs sold as separate. Suitable for both RVL , RVH, RCL and RCH legs and bars.

Important Information

1. Check Part No./Kit is correct
2. Read through instruction before installing
3. Fit roof rack accessory
4. Check and recheck all fasteners are secure

Maximum carrying capacity: 75kg (165lbs) evenly distributed over crossbars when mounted on the strongest section of the roof. Please refer to your vehicle manufacturers handbook for maximum roof loading. Always use the lower of the two figures. Note: Be sure to check the Rhino-Rack website to see if you have the latest version of instructions before beginning.

Advisory:

It is essential that all bolt connections be checked after 48hrs from when you first install your crossbars. Bolt connections should be checked again at regular intervals (once a week is enough, depending on road conditions, usage, loads and distances travelled). You should also check the crossbars each time they are refitted. Make sure to fasten your load securely. Please ensure that all loads are evenly distributed and that the centre of gravity is kept as low as possible.

Use only non-stretch fastening ropes or straps.

Load Ratings

When these roof racks are to be used on a vehicle that is driven off sealed roads, the manufacturer maximum roof load rating (to be found in the vehicle's User Manual) should be divided by a safety factor of **2**. For example, if the vehicle's maximum roof load rating is 75kgs\165lbs, these racks, when fitted to this vehicle should have no more than 37.5kgs/82lbs loaded on them.

Caution:

The handling characteristics of the vehicle changes when you transport a load on the roof. For safety reasons we recommend you exercise extreme care when transporting wind-resistant loads. Special consideration must be taken into account when cornering and braking. **Please remove crossbars when putting vehicle through an automatic car wash.**

Note for Dealers and Fitters: It is your responsibility to ensure instructions are given to the end user or client.

Rhino-Rack
3 Pike Street, Rydalmere,
NSW 2116, Australia.
(Ph) (02) 9638 4744
(Fax) (02) 9638 4822

Document No: R1326
Prepared By: Kayle Everett
Authorised By: Chris Murty

Fit Time: 30min
Issue No: 01
Issue Date: 10/04/2017

These instructions remain the property of Rhino-Rack Australia Pty. Ltd. and may not be used or changed for any other purpose than intended.



RCP48-BK Base Kit

Parts List

Item	Components	Qty	Part No.
1	Short Fixed Mount Rotation Block	4	M835
2	Short Fixed Mount Base Cover	8	M836
3	Short Fixed Mount Base	4	M834
4	Tall Fixed Mount Flat Rubber	4	M838
5	M6 x 35mm Hex Setscrew	4	B203
6	M6 Spring Washer	4	W004
7	M6 16mm Flat Washer	4	W031
8	M6 Fix Point Adaptor	4	CA1188
9	Cover Plate	4	M126
10	M6 Washer (used on cover plate)	4	W003
11	Instructions	1	R1326

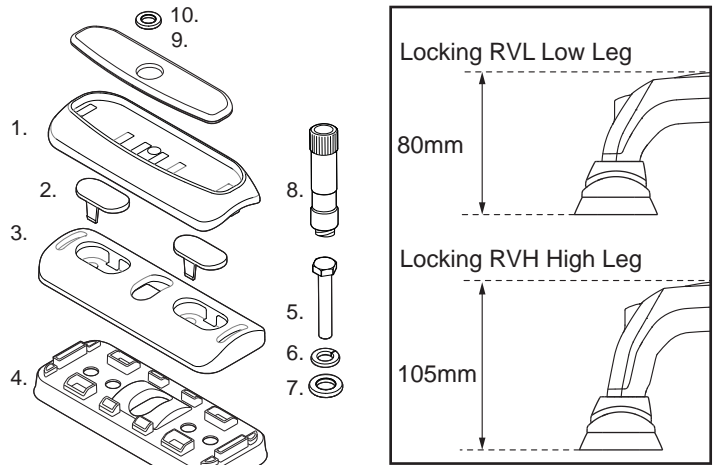

Tools Required: 10mm socket wrench. **Note:** Legs and Crossbars are sold separate. Be sure to obtain correct kits for your vehicle.

Instructions

1 Assemble the short mounts as shown.

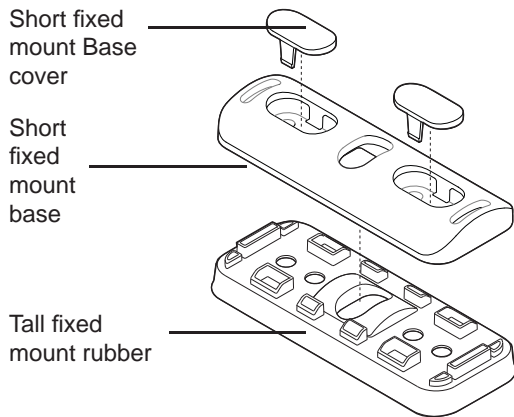

2 Place the short fixed mount rotation block onto the assembly.

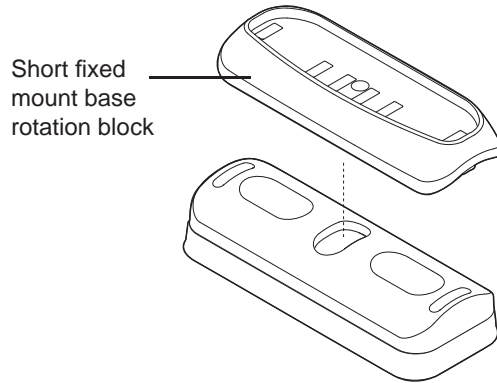

3 Carefully remove the ditch fill. Refer to vehicle owners manual. If the mounting points in the roof can be easily exposed and mount rubber can clear mount windows without interference, move to step 6.

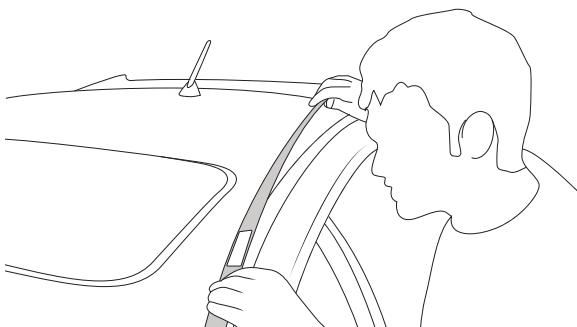

Images are example only. Process will vary vehicle to vehicle.

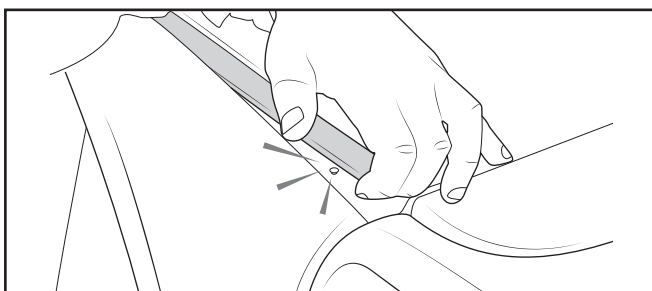

4 Open the window in the ditch fill.

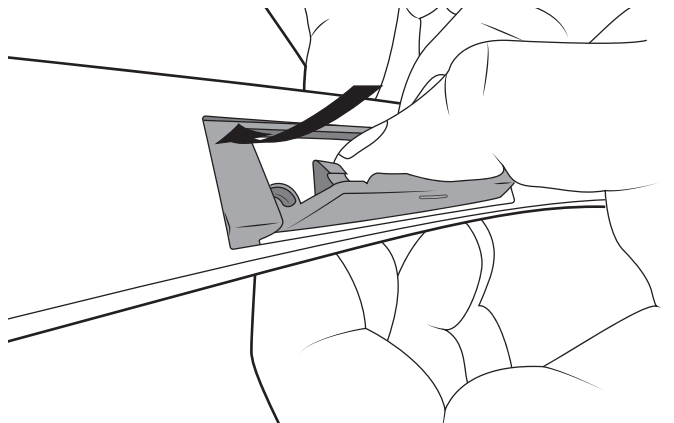
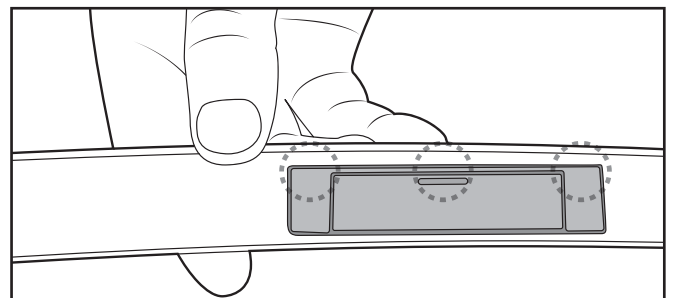



RCP48-BK Base Kit

5 Remove the windows from the ditch fill.

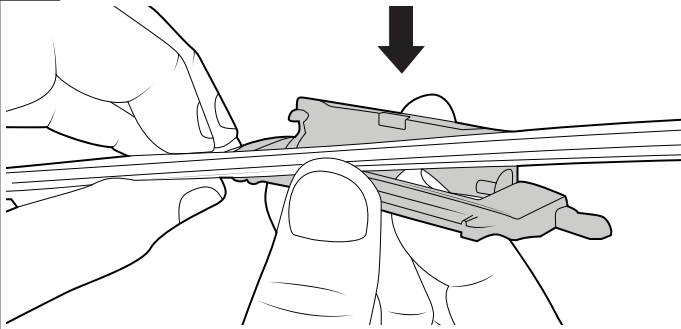

Replace the fill into the roof ditch.

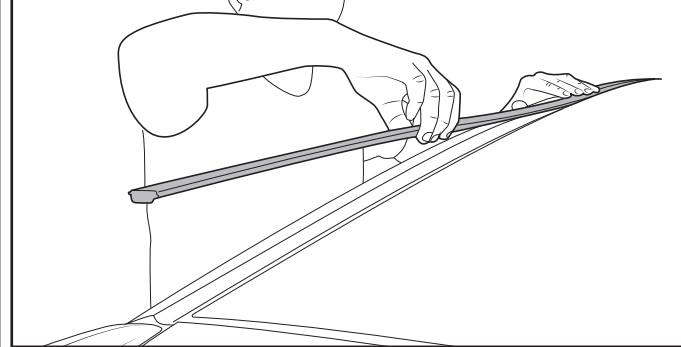

6 Install the M6 fix point adaptors.

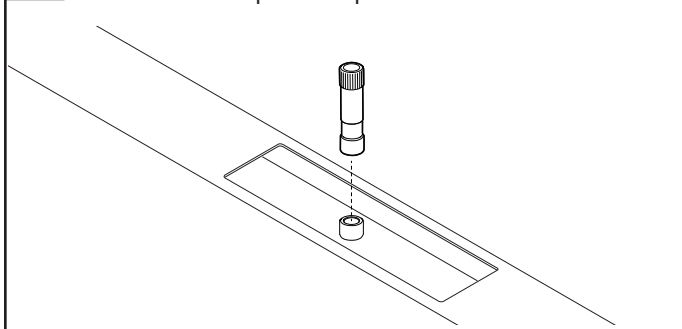

Be sure the adaptors are secure.

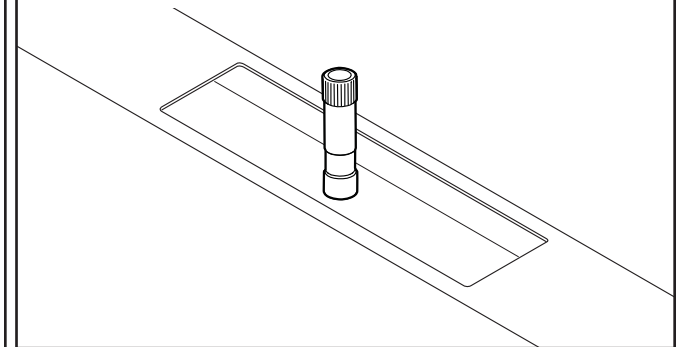

7 Place the completed fixed mount assembly over the installed adaptors as shown.

1.

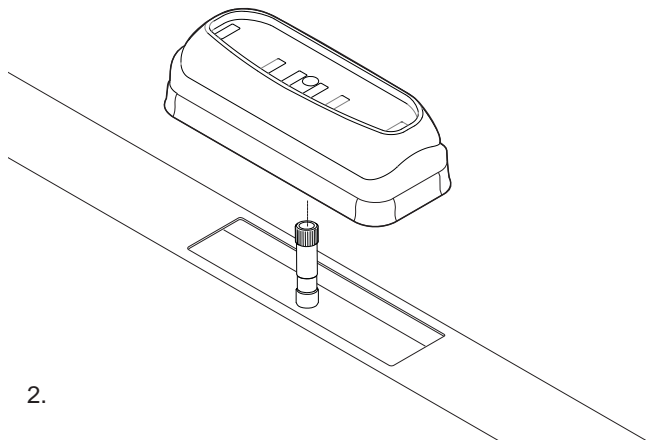

2.

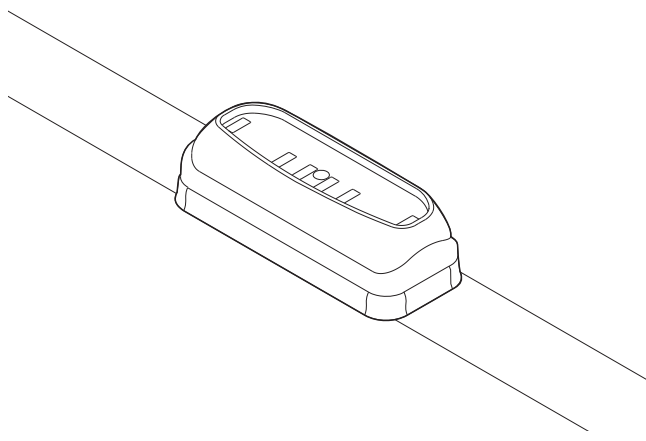

8 Install crossbars as per crossbar individual instructions. RVL crossbars shown as example only.

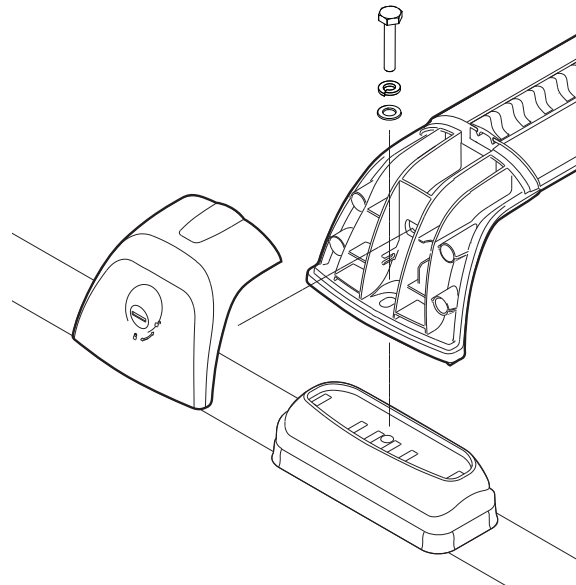

Be sure fixtures are secure before use.

