

Anbauanleitung: Unterfahrschutz Motor
Mercedes Sprinter 906 Allrad Bj.2013-2018
Mercedes Sprinter 907 Allrad Bj.2018-2022

AL: 2332-01

Best.Nr.: 29-T060406

Montagezeit: ca. 30 min.

***Hier sehen sie den fertig montierten Unterfahrschutz.
Bevor sie mit der Montage beginnen, lesen sie bitte diese Anleitung gut durch.***

*Here you see the ready mounted skid plate.
Before you start fitting, please read and understand this instruction manual.*



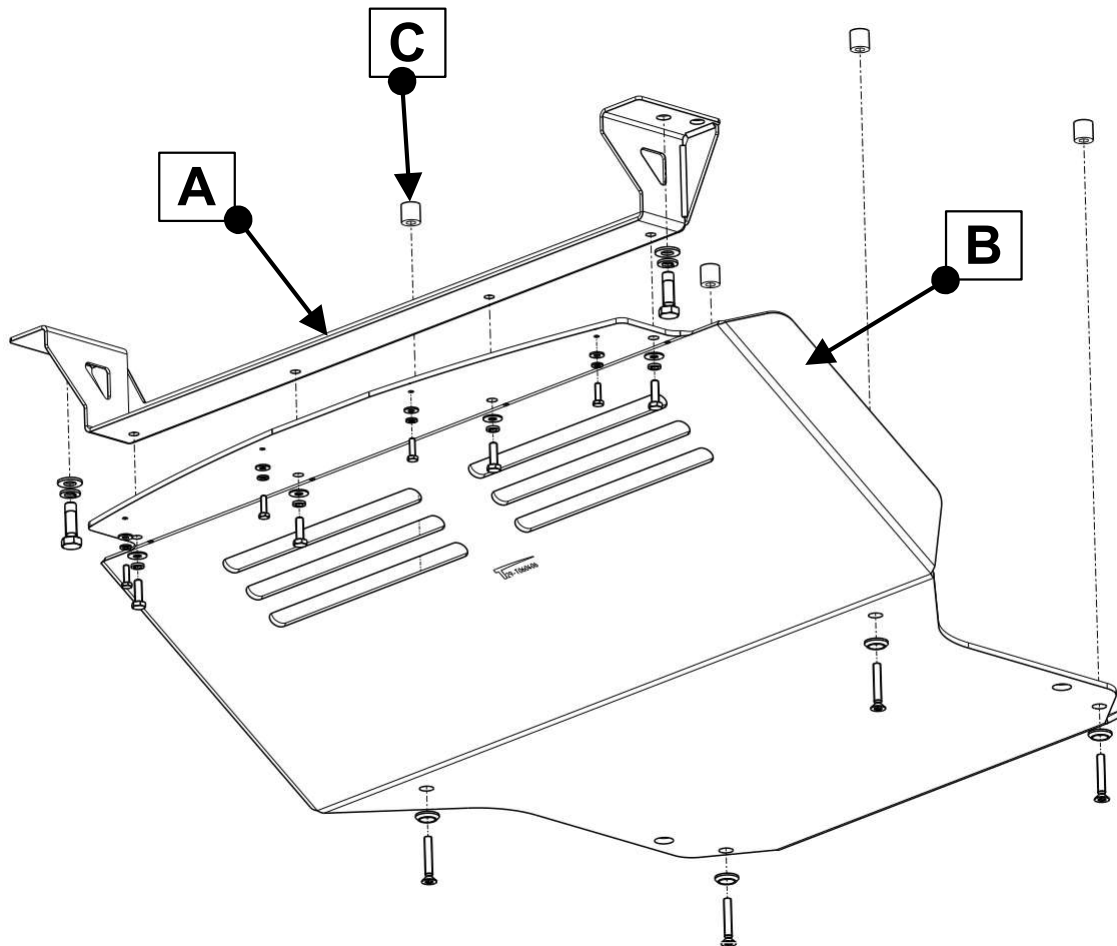

Stückliste

Schraubensatz

1x Traverse **(A)**
 1x Schutzplatte **(B)**
 4x Distanzhülse Ø20 x 20 **(C)**

1x Anleitung AL2332

2x Scheibe M12 x 26 x 2,5
 2x Federring M12
 2x Schraube M12 x 1,5 x 40

3x Blechmutter M8, Typ6

4x Scheibe M8 x 20 x 1,5
 4x Federring M8
 4x Schraube M8 x 25

5x Senkscheibe M8 Alu
 5x Senkschraube M8 x 50 (ISO14581)

Nur notwendig für Sprinter 907 zur unteren Befestigung des Stoßfängers:

4x Scheibe M6 x 15 x 1,5
 4x Federring M6
 4x Schraube M6 x 20

Schrauben Anzugsmomente	
Schraubengröße	Güteklasse - 8.8
M6	10 Nm
M8	25 Nm
M10	50 Nm
M12	87 Nm
M14	138 Nm
M16	210 Nm

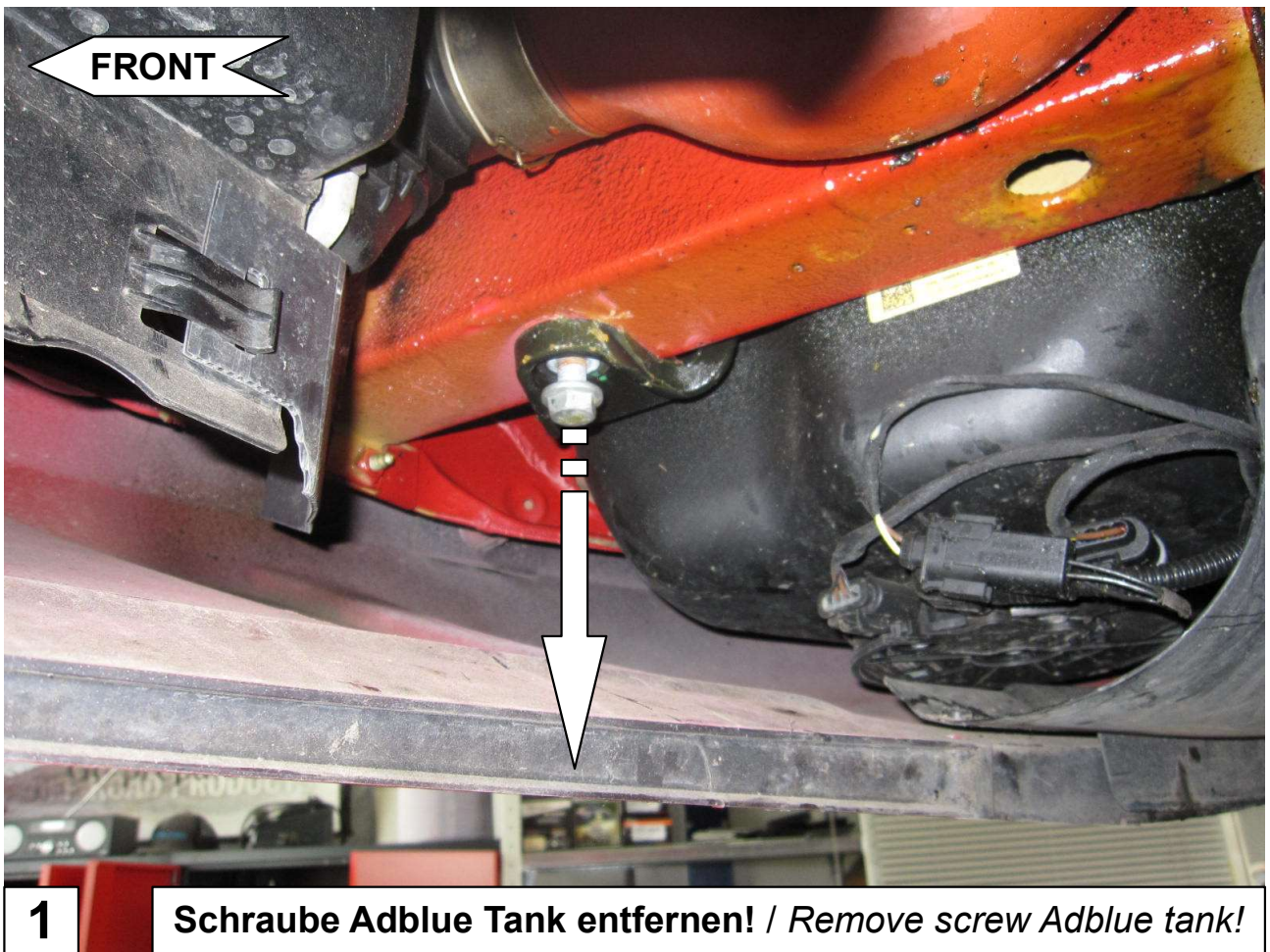



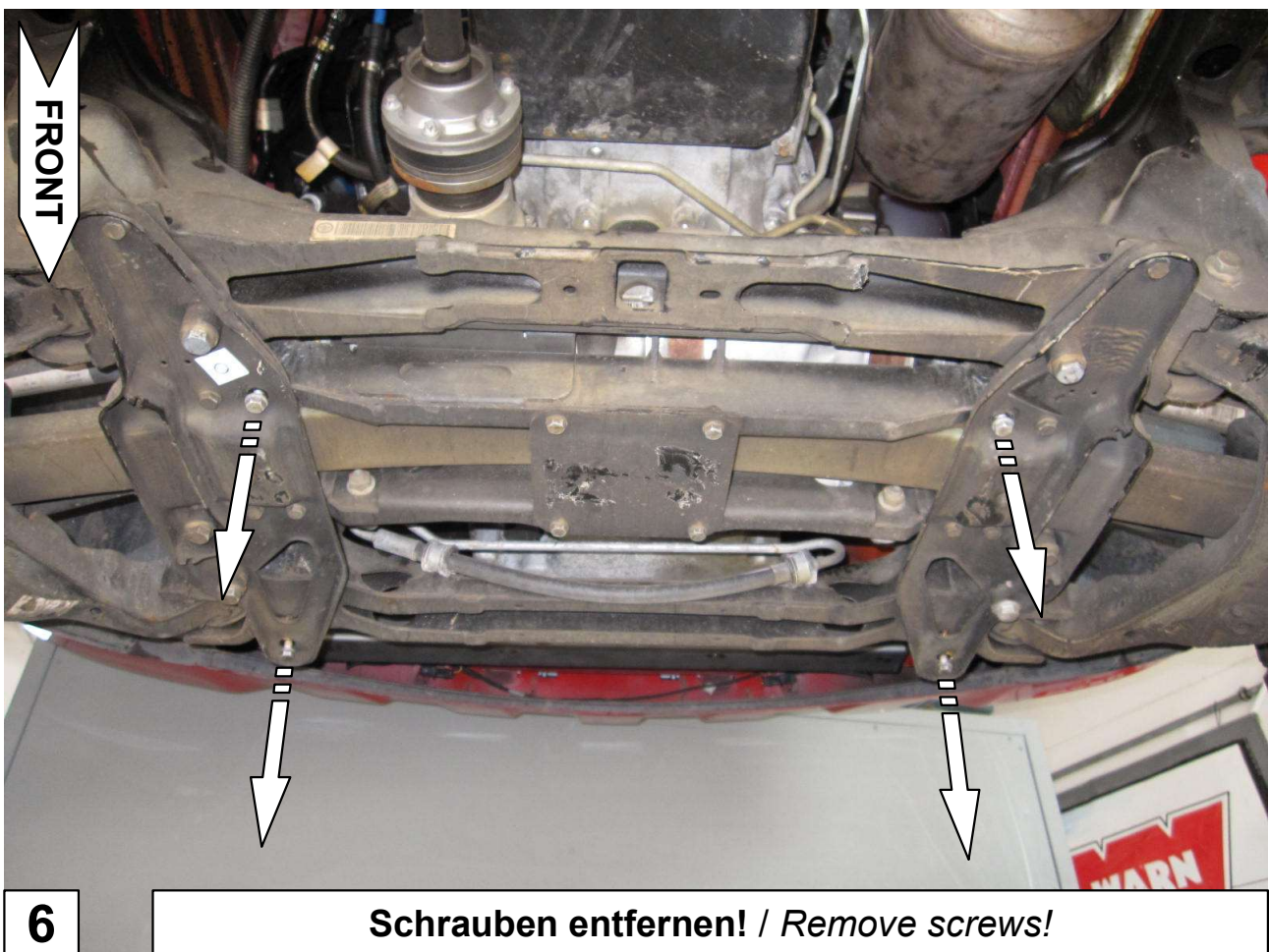
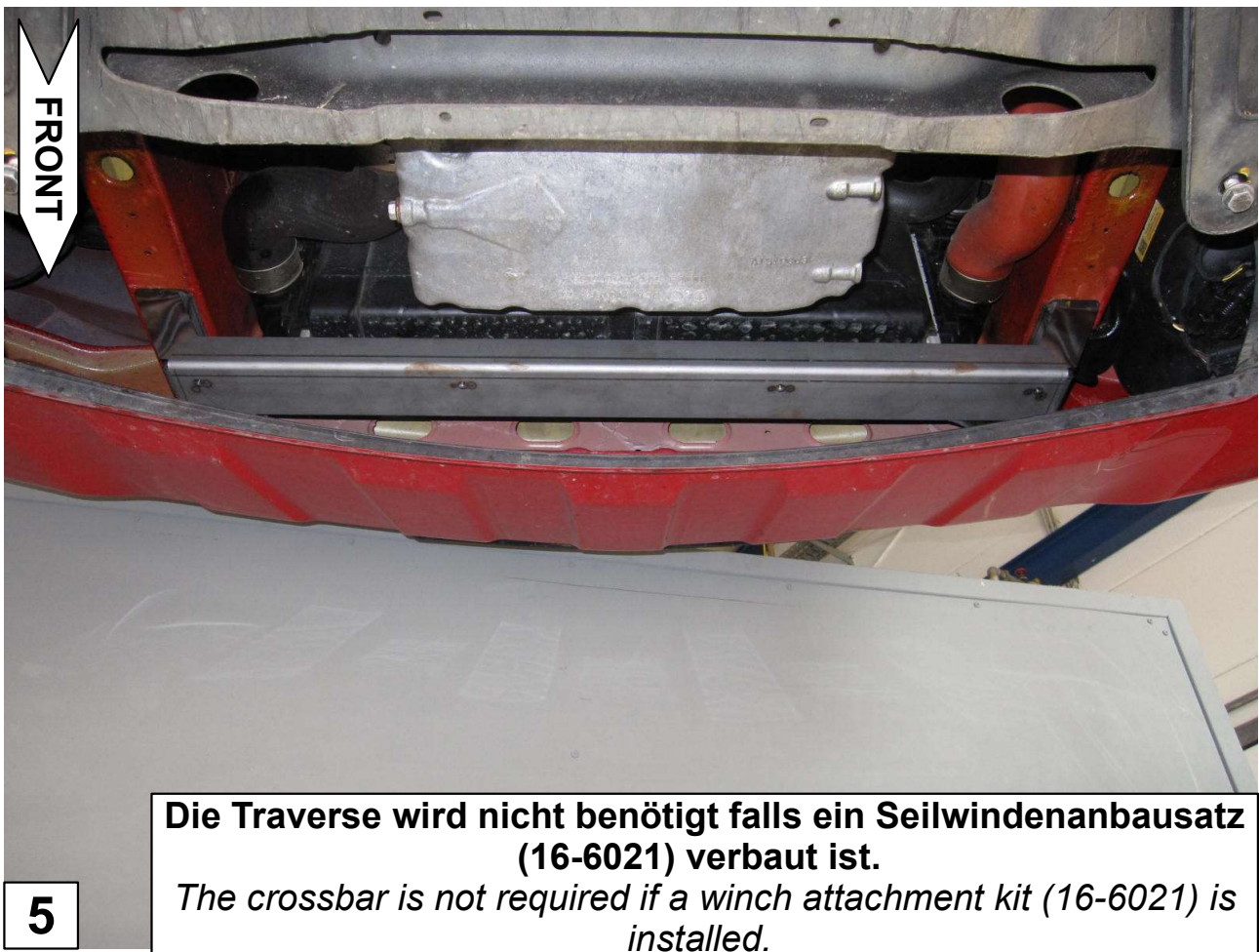

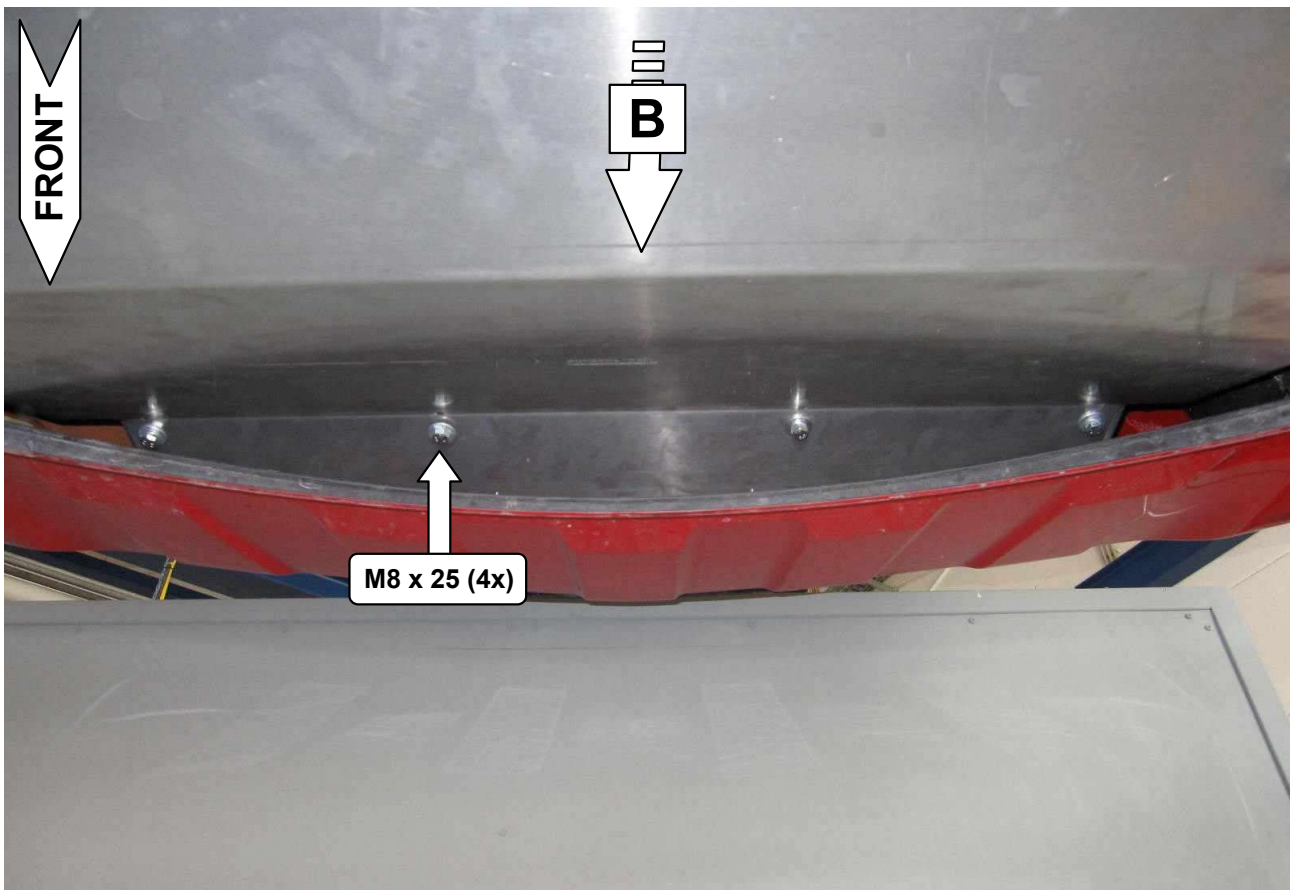

7

Schutzblech an der Traverse befestigen!
Mount the protective plate at the crossbar!

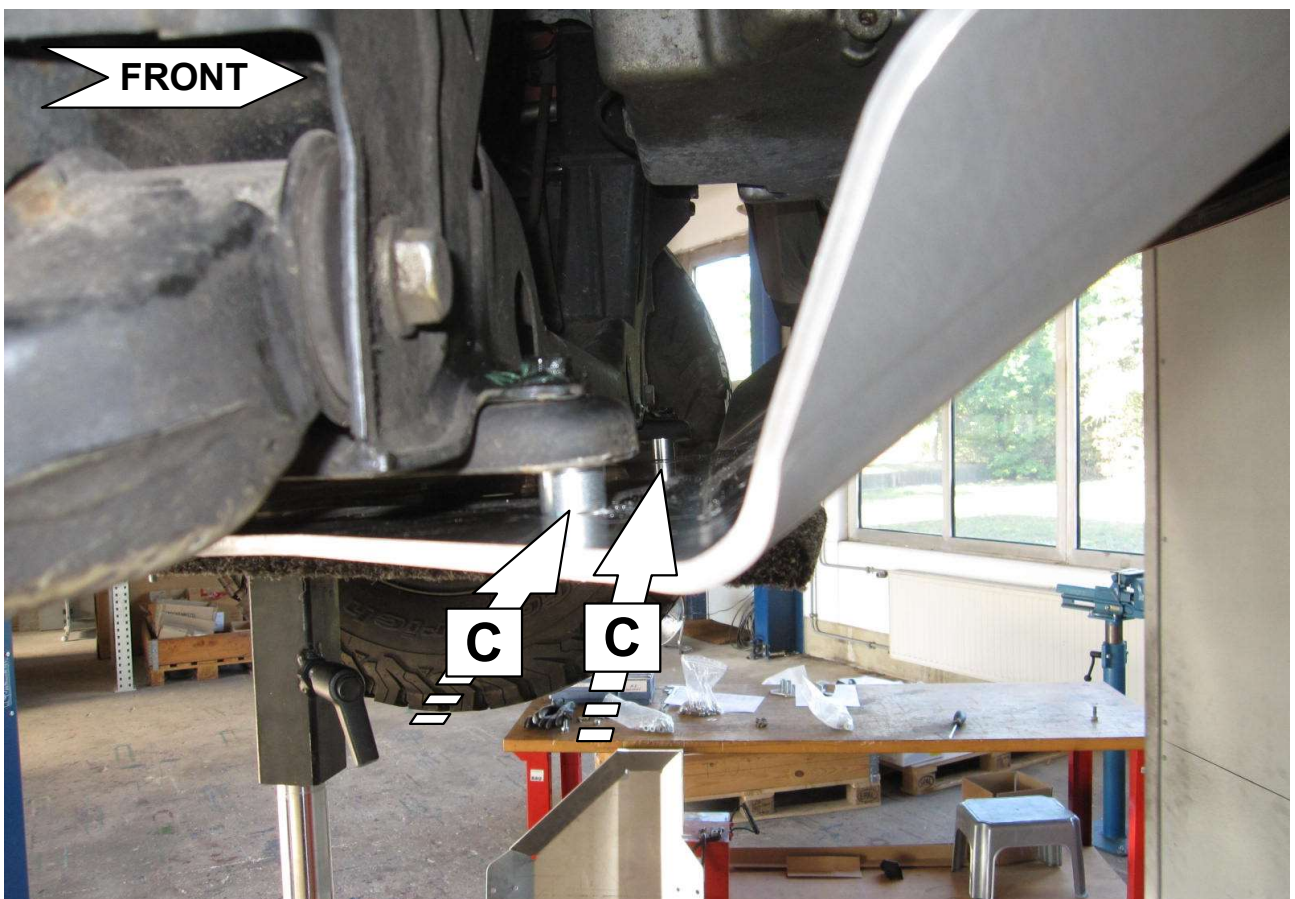

8

Distanzhülsen vorne einlegen! / Insert the spacers at the front!

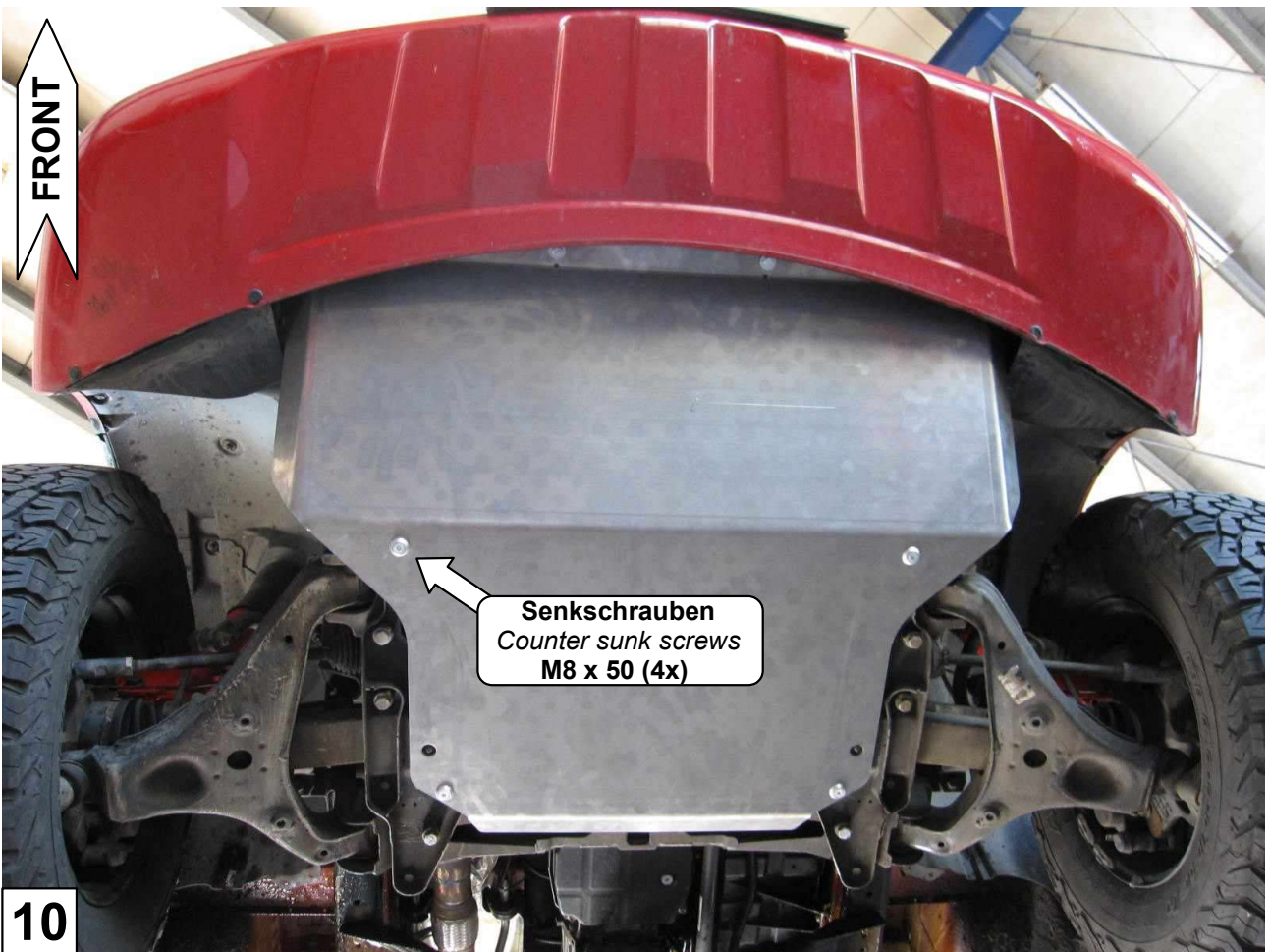
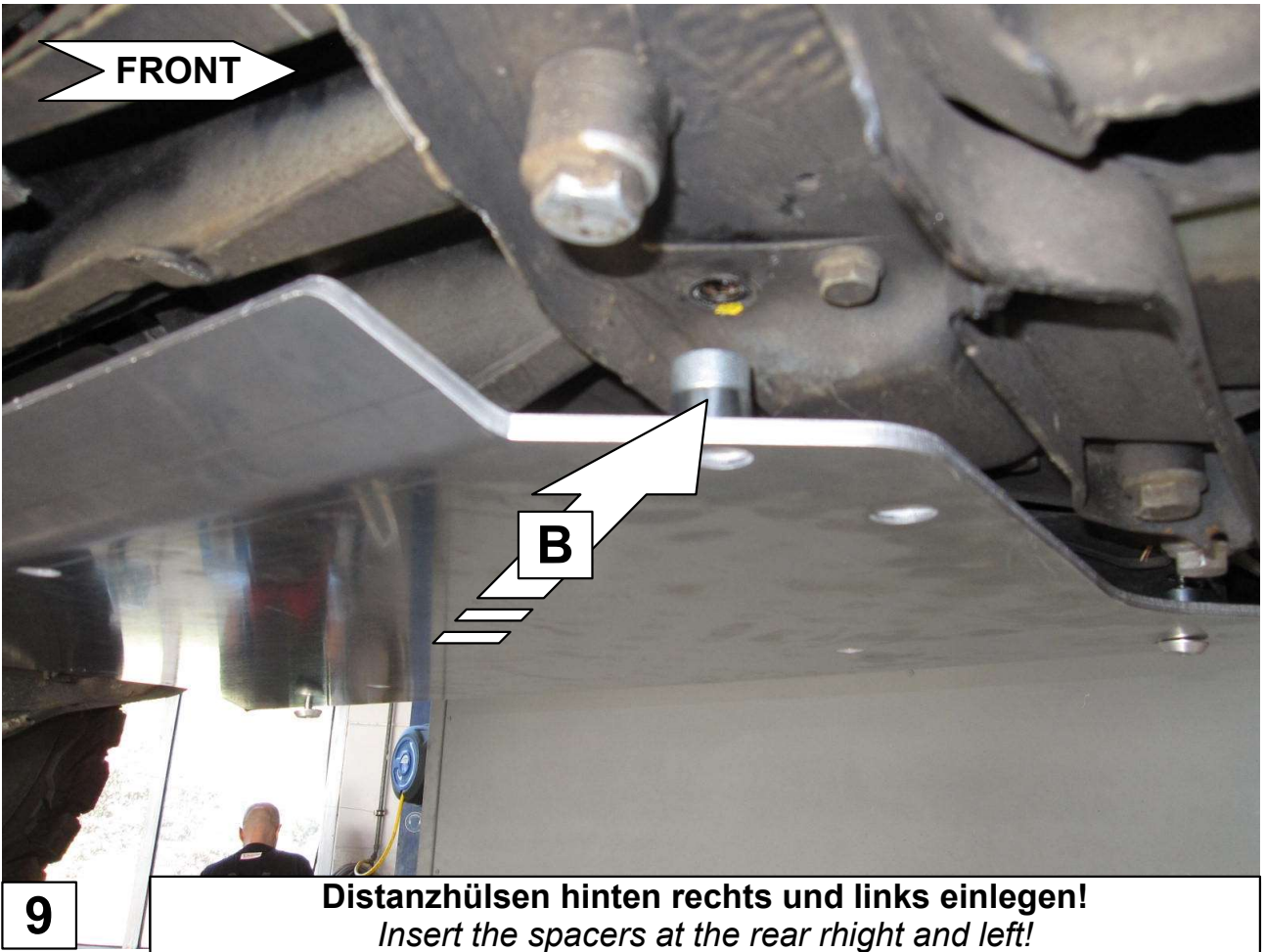

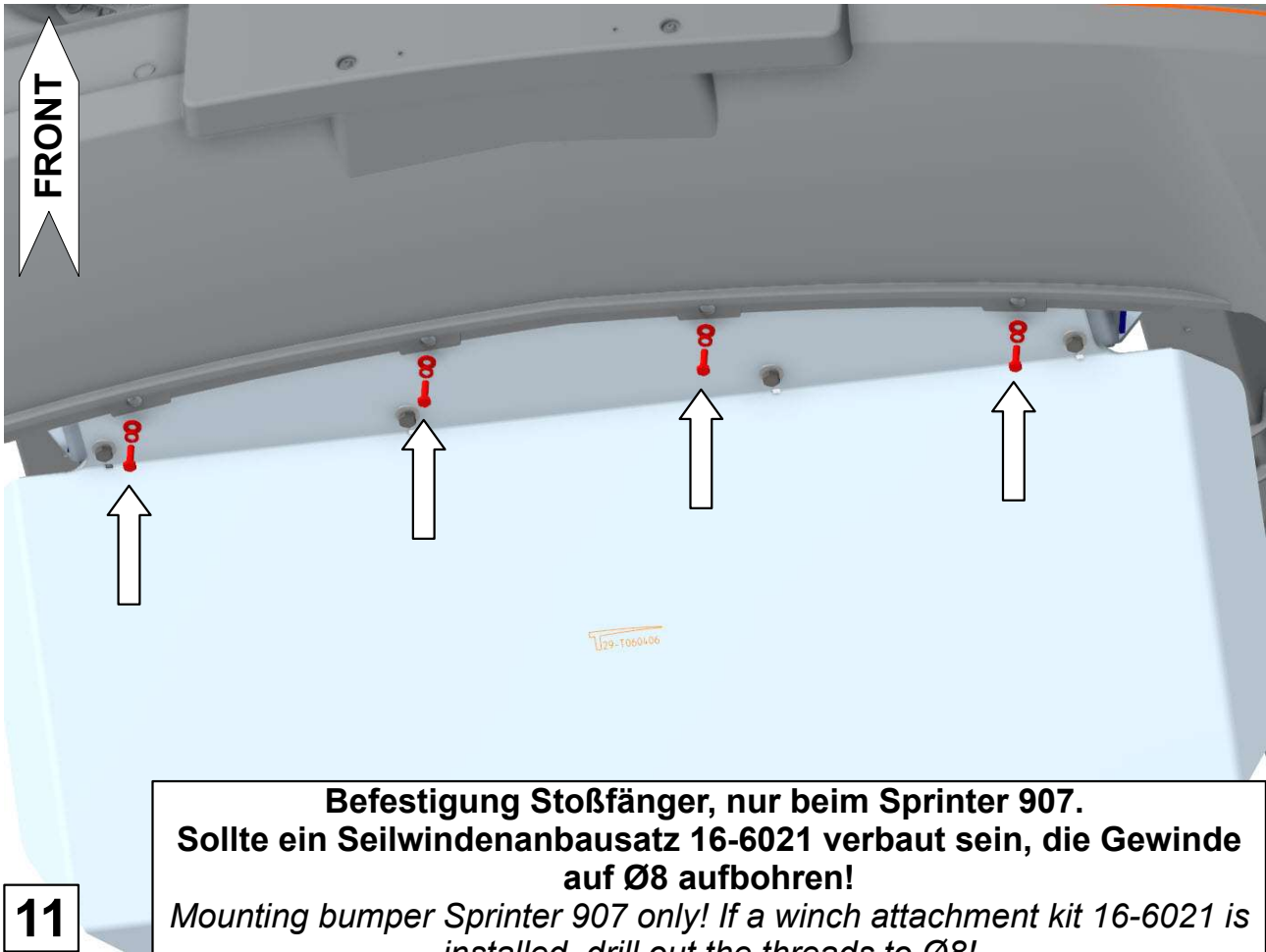

Befestigung Stoßfänger, nur beim Sprinter 907.
Sollte ein Seilwindenanbausatz 16-6021 verbaut sein, die Gewinde auf Ø8 aufbohren!
Mounting bumper Sprinter 907 only! If a winch attachment kit 16-6021 is installed, drill out the threads to Ø8!