

Anbauanleitung Multi Mount Anbausatz *Fitting Instruction Multi-Mount- kit* Toyota J15 – J12

Best.-Nr.: 1 - 25937

AL: 2005 – 00



**Hier sehen sie die fertig montierte Frontaufnahme.
Bevor sie mit der Montage beginnen lesen sie bitte diese Anleitung
und das Benutzerhandbuch der Seilwinde gut durch.**

Achtung:

Bei Fahrten im öffentlichen Straßenverkehr muß die Aufnahme mit der Kunststoffabdeckung Best.nr.: **1 - 37509** abgedeckt werden.

*Before you start fitting, please read and understand this instruction manual
and the owners manual of the winch.*

Stückliste / Parts list
Multi Mount Anbausatz/ Multi mount kit
Toyota J 15 – J12
Best.nr.: 1- 25937

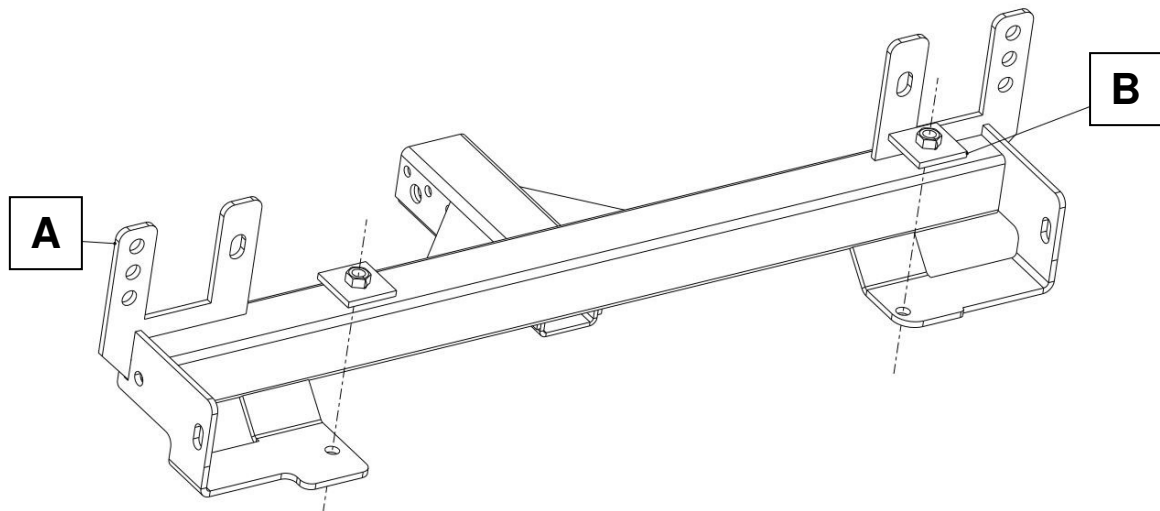

1 x Frontaufnahme (A)	2 x Schraube M 12 x 1,25 x 30
2 x Gegenplatte (B)	2 x Schraube M 12 x 60
1 x Kunststoffabdeckung 1 – 37509	2 x U – Scheibe M 12
1 x Anbauanleitung AL 11	4 x U – Scheibe M 12 x 30 x 3
1 x Gutachten	4 x Federring M 12

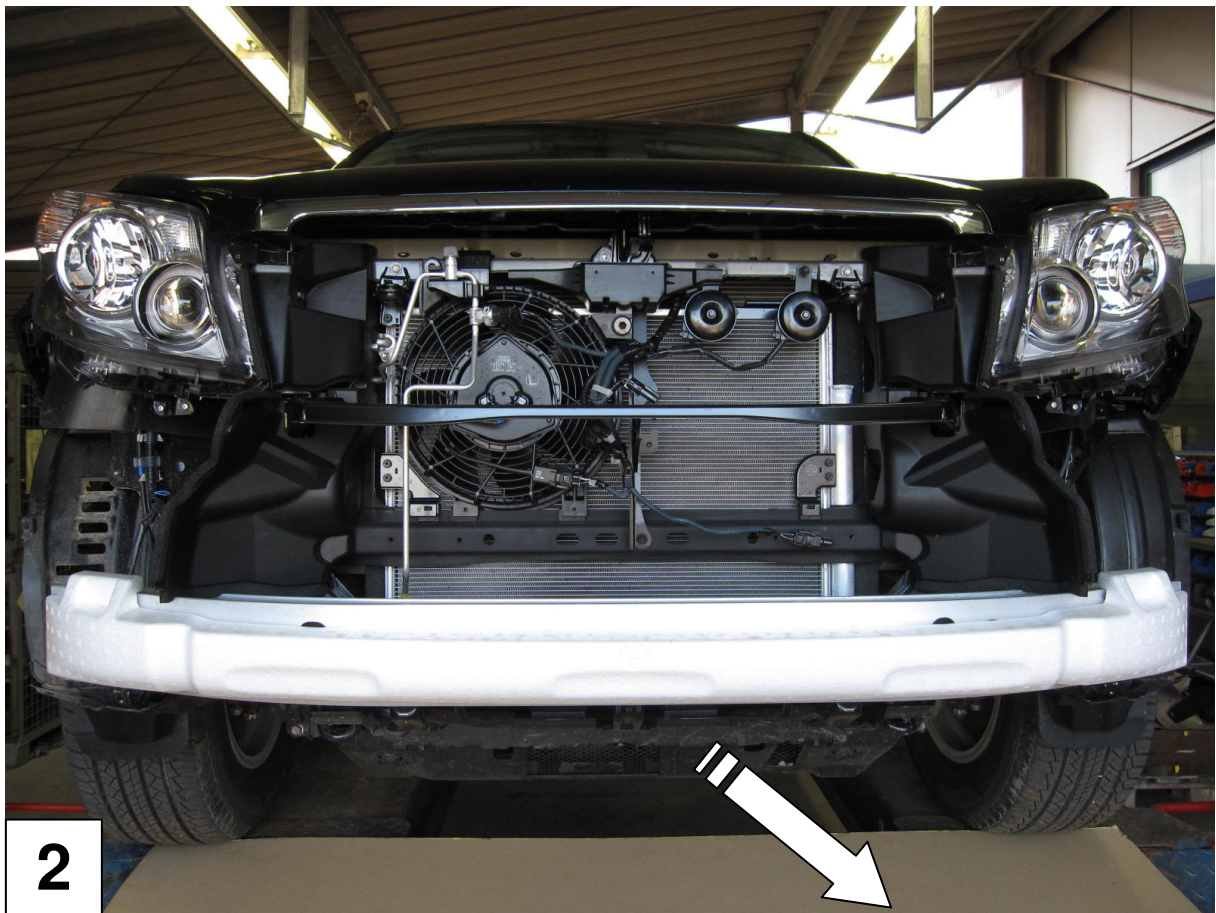
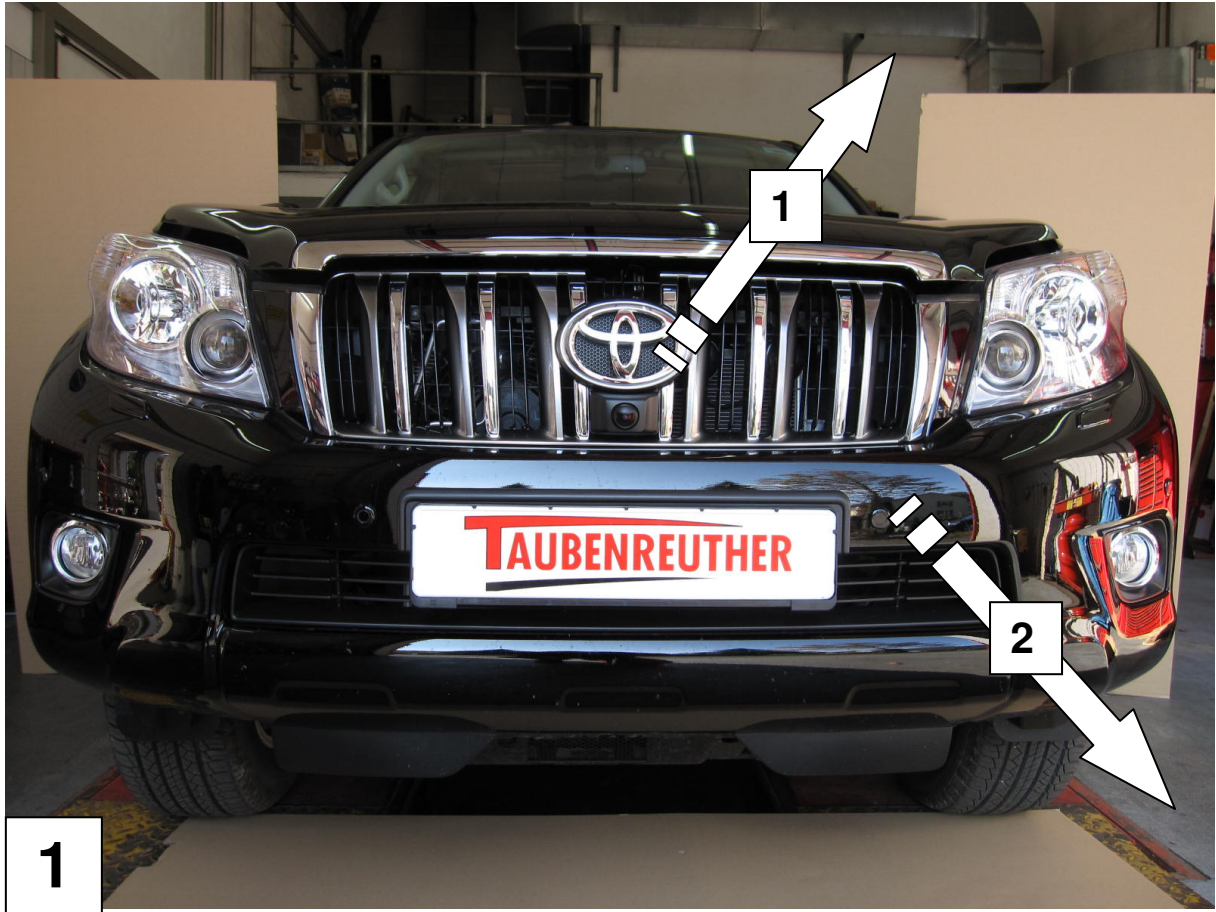

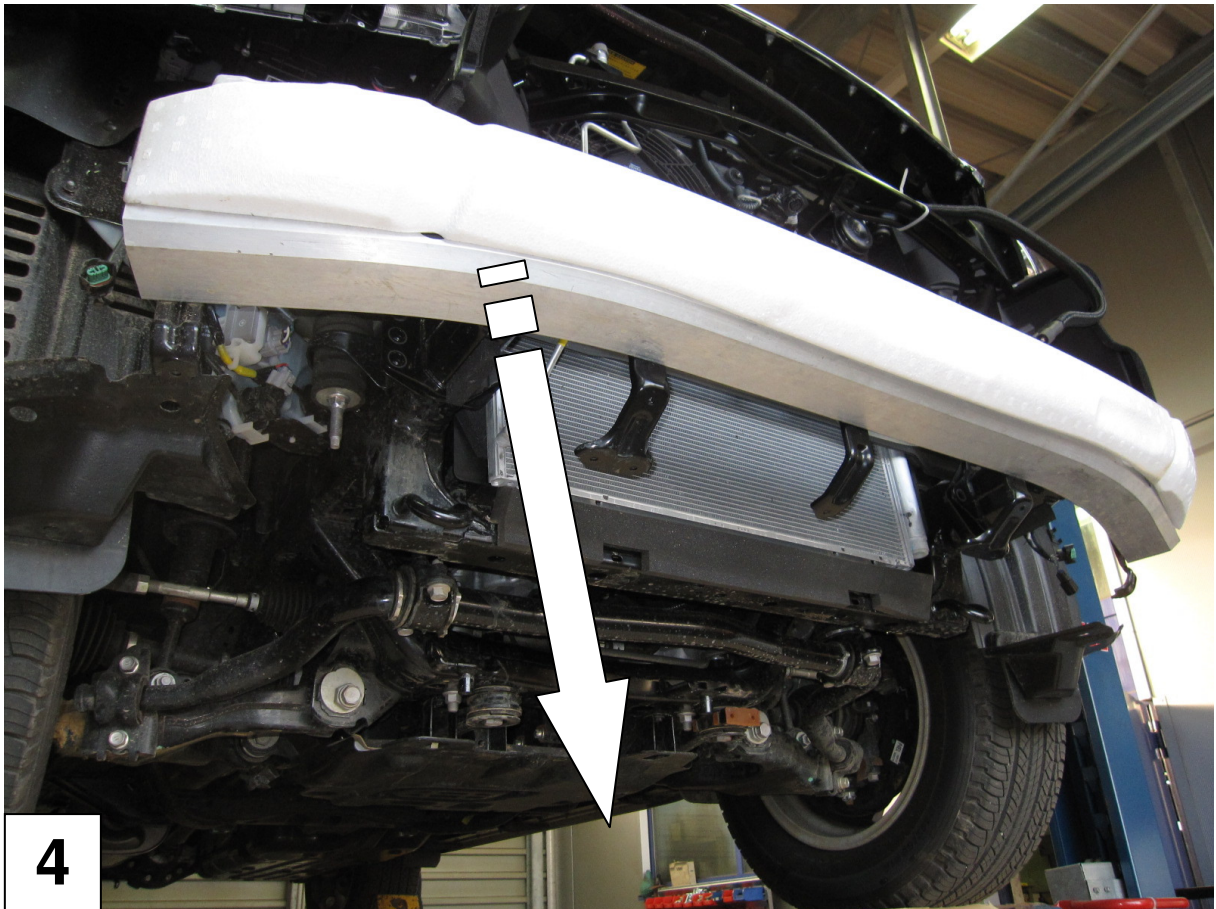



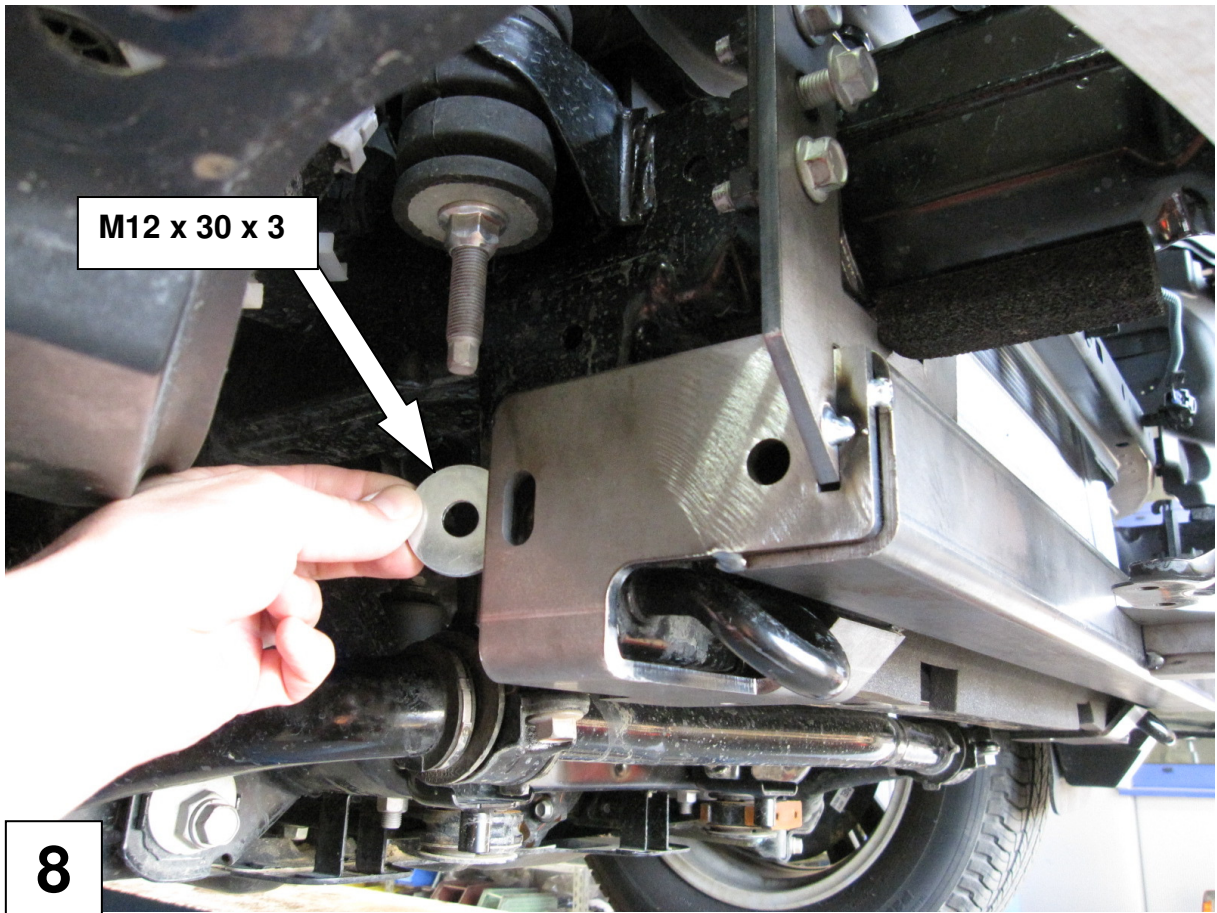
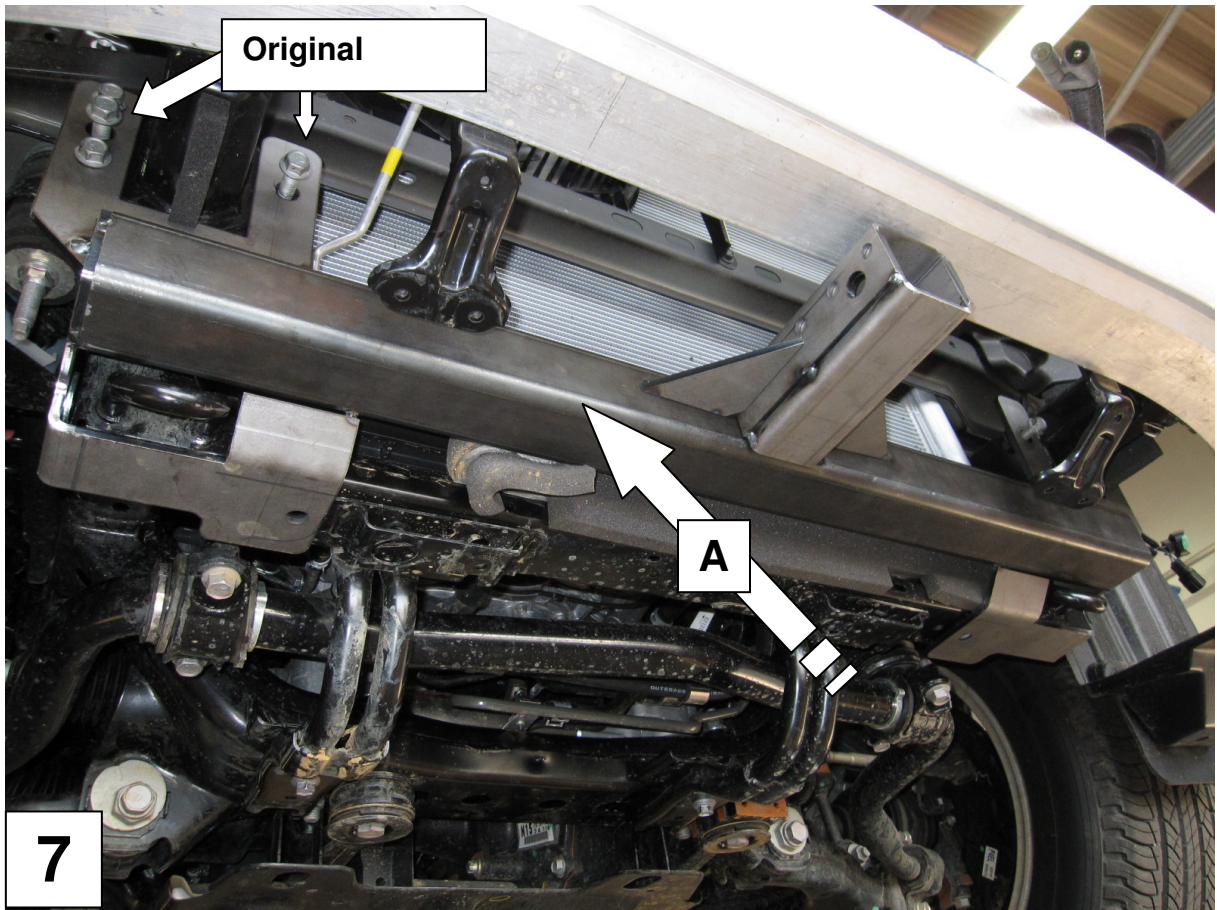

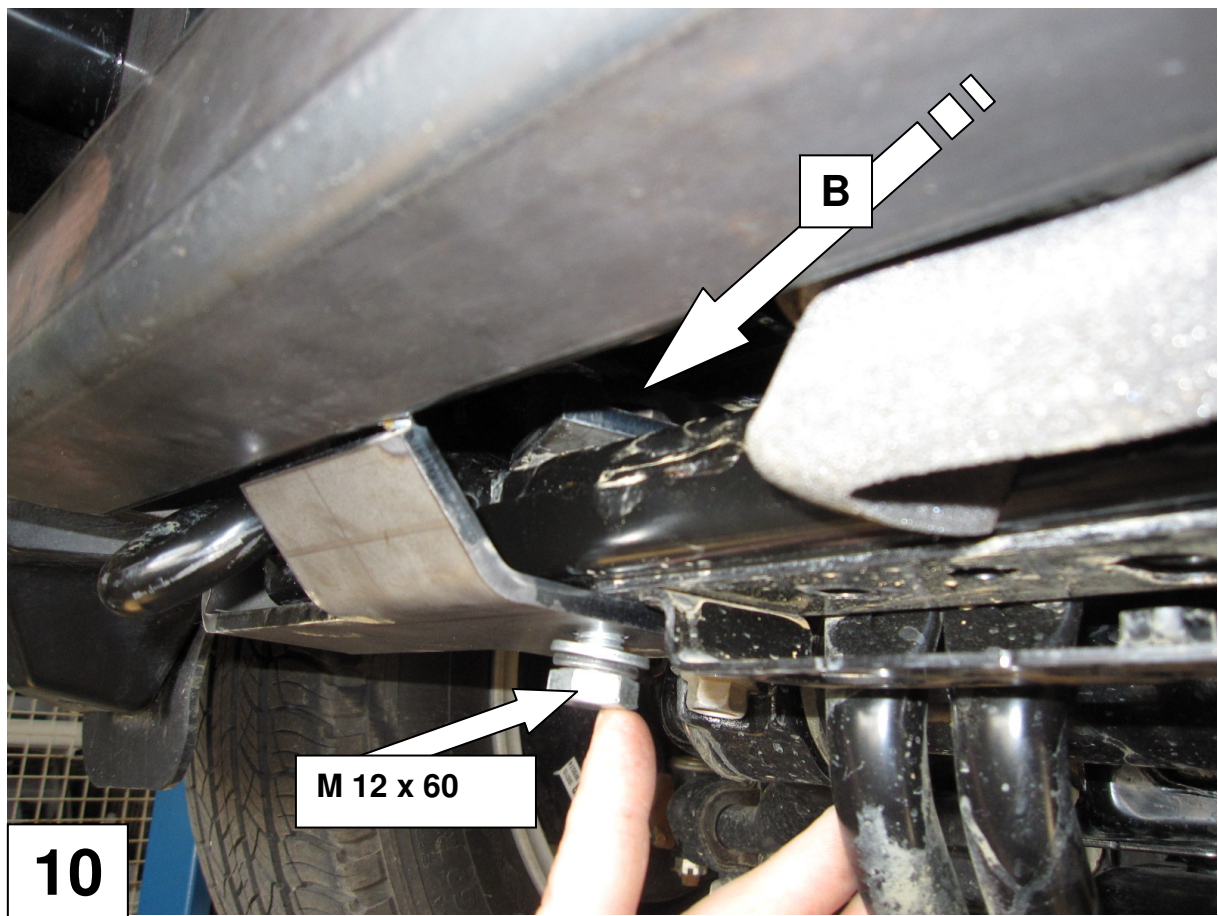
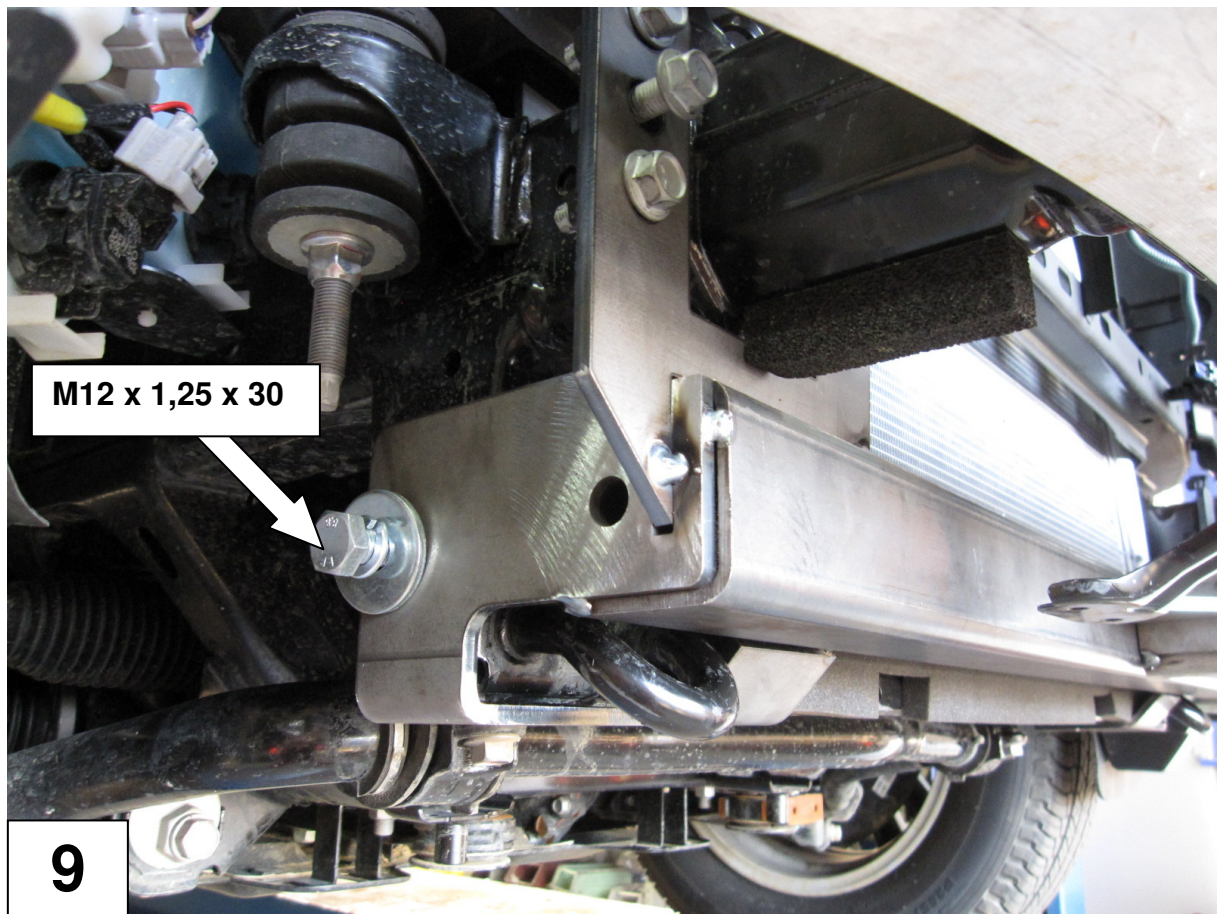

Ziehen Sie die Schrauben in der gezeigten Reihenfolge fest !

Tighten the screws in the raw, as shown in the picture!

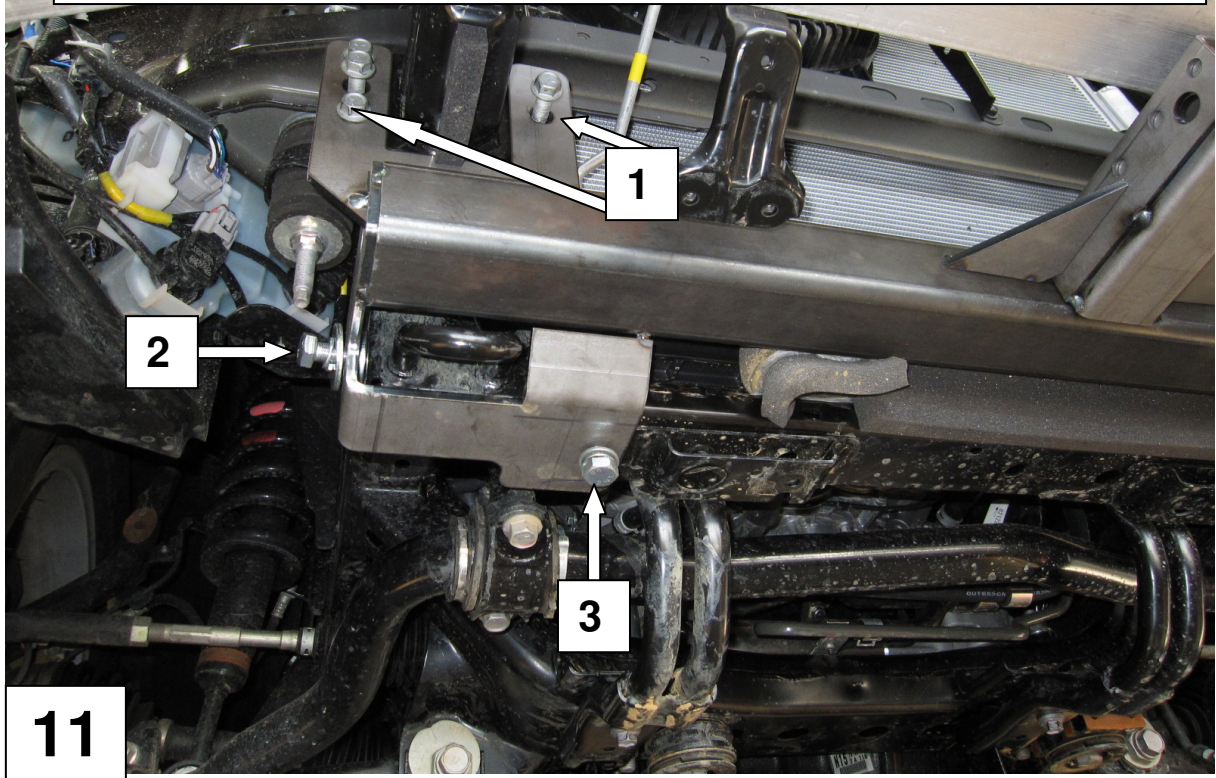

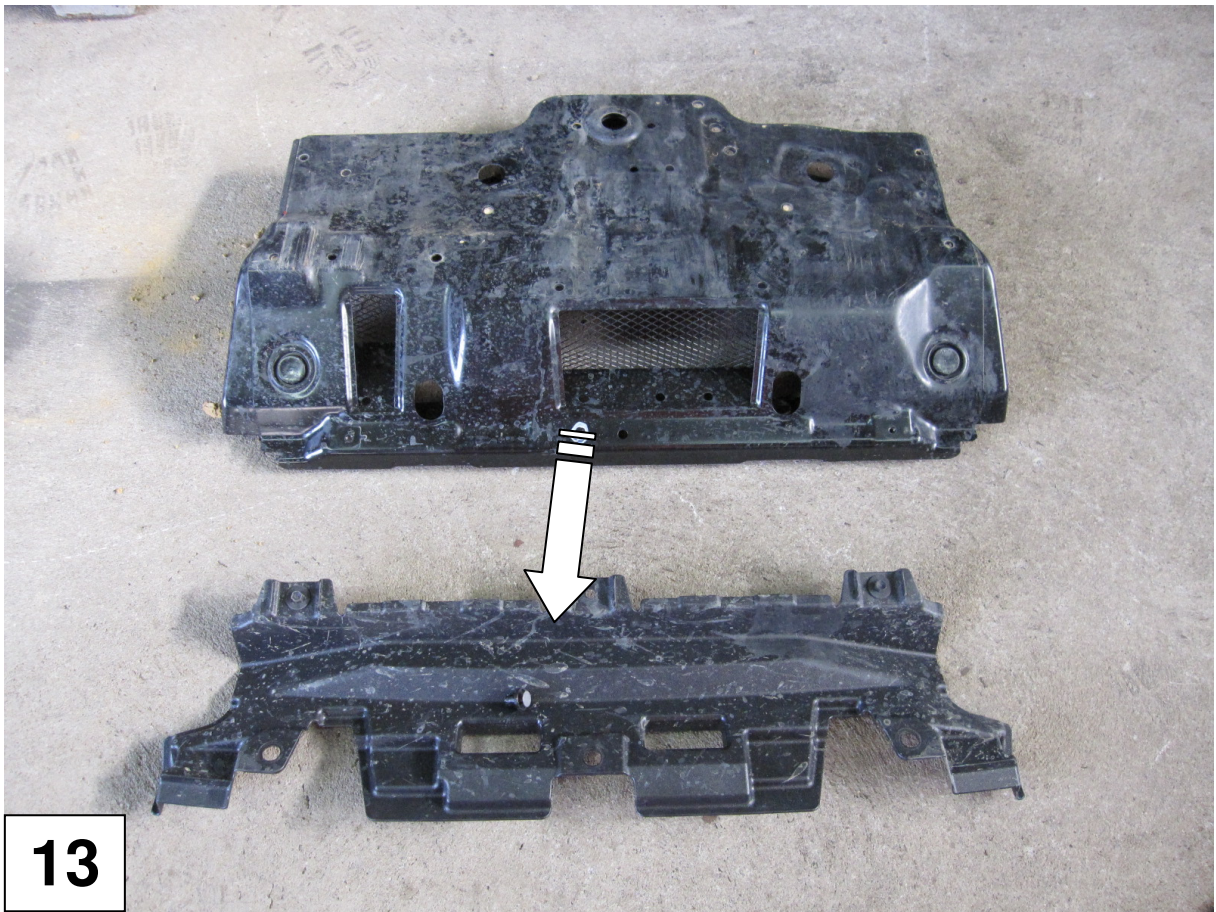

13

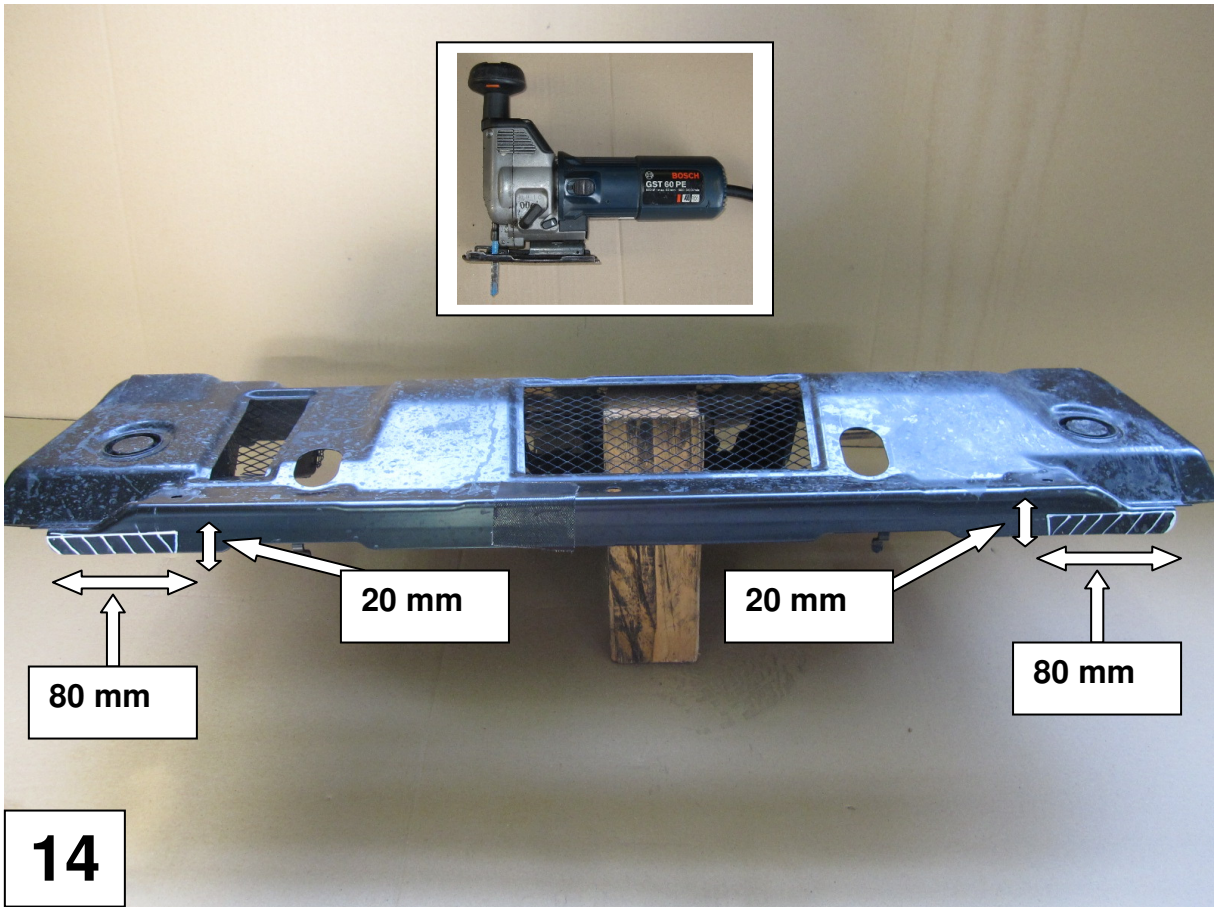

14

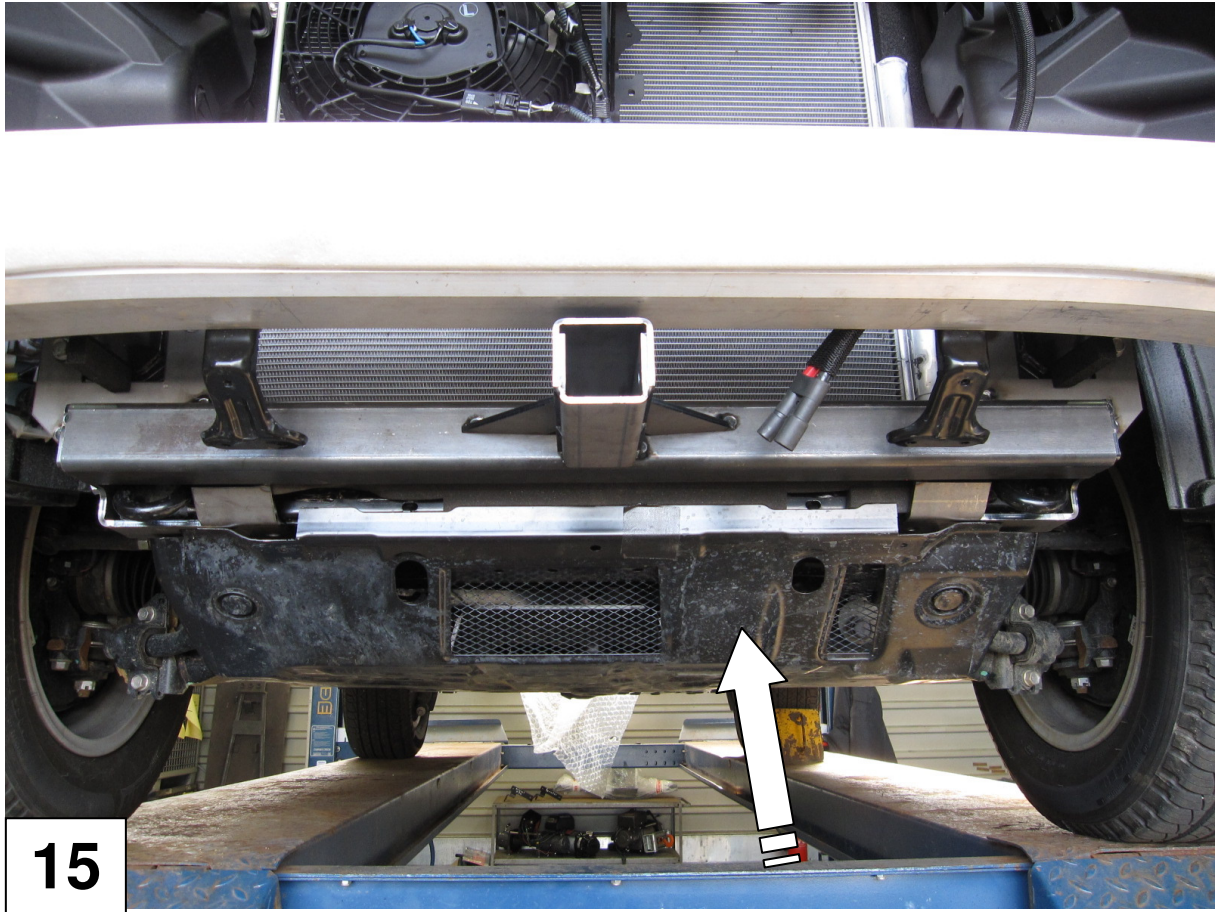

15



16