

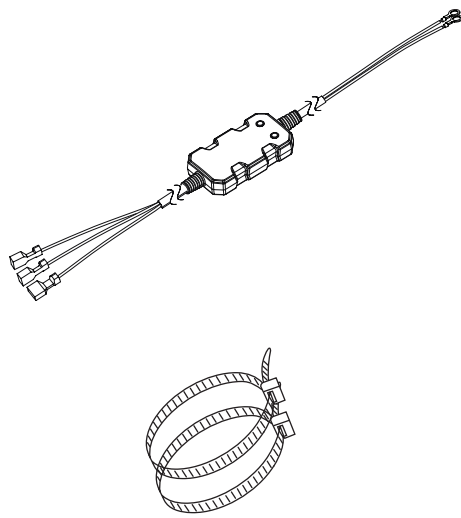

Quick Start Guide

UNIVERSAL WARN® HUB Receiver

KIT CONTENTS



BEFORE YOU BEGIN

1.

Download the WARN® HUB App (HUB App) from the App Store or Google Play.

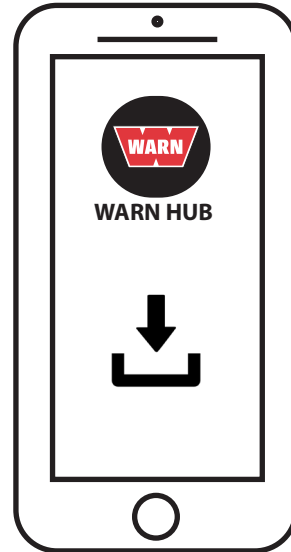

Data rates may apply.
Apple is a trademark of Apple Inc., registered in the U.S. and in other countries. App Store is a service mark of Apple Inc.
Google Play is a trademark of Google Inc.

MOUNT



2.

Determine mounting location and wire routing path.
Recommendation: Under vehicle hood, on vehicle frame or along other wiring bundles. Avoid sharp edges, heat and moving parts.

3.

Using the included zip-ties, mount HUB Receiver firmly to vehicle.

4.

Route spade terminal ends of the HUB Receiver to the winch control pack/contactor. **NOTE:** Make sure to route wires/cables away from sharp edges, heat and moving parts.

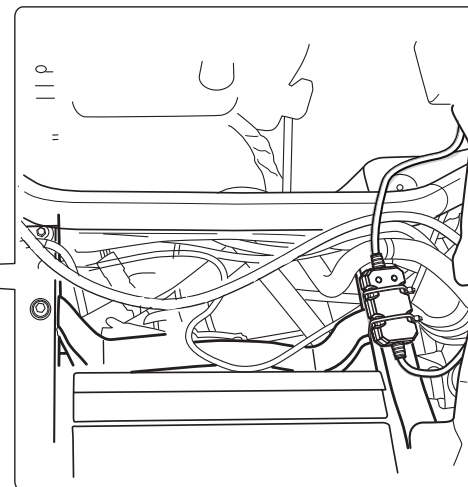

Quick Start Guide

UNIVERSAL WARN® HUB Receiver

WIRE

5. **WARNING** All work with electrical wires and cables must be completed with the battery completely disconnected from the vehicle wiring.

- Disconnect vehicle power.
- Connect the HUB Receiver's spade terminal wires to the contactor's spade connectors*.
- Connect HUB Receiver's red wire to key-on ignition wire.
- Connect black wire to vehicle ground.
- Reconnect vehicle power.

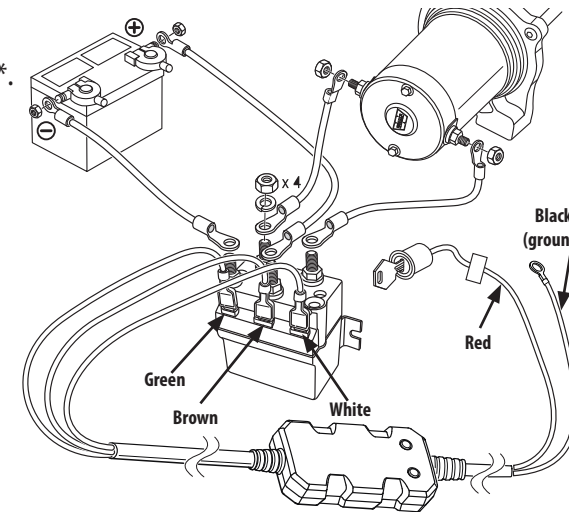

* Illustration depicts wiring a powersports contactor. For winches with a control pack, the spade terminal colors may differ. See owner's manual for details.

POWER

6.

Turn vehicle power on.

NOTE: The HUB Receiver is active when the yellow light is on.

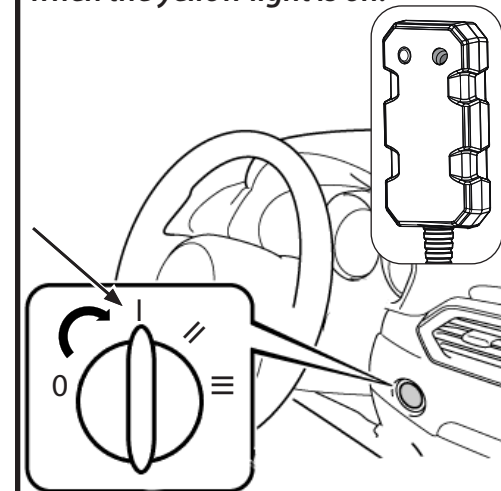

PAIR/CONNECT

7.

Press and hold button on HUB Receiver until blue light flashes (approximately 2 seconds) and then release button.

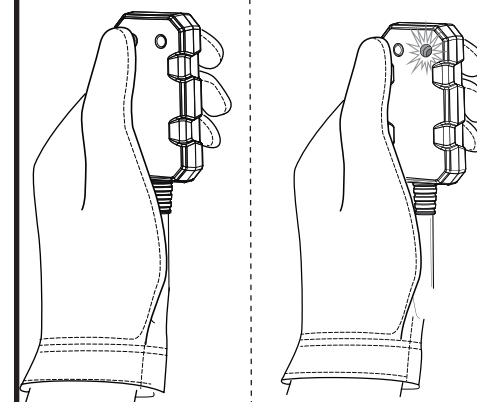

8.

Open app on phone and follow prompts.



9.

When light on HUB Receiver turns green, you are connected. Continue following the instructions through your app.

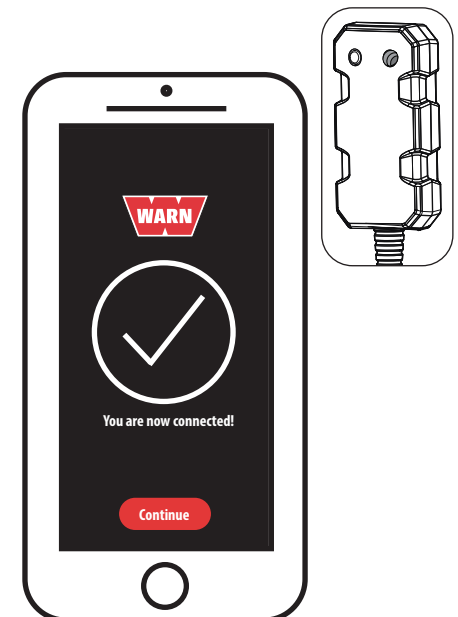

CUSTOMER SERVICE

WARN INDUSTRIES, INC. 12900 S.E. Capps Road,
Clackamas, OR USA 97015-8903, 1-503-722-1200
Customer Service: 1-800-543-9276
Dealer Locator Service: 1-800-910-1122



Guide de démarrage rapide

RÉCEPTEUR HUB WARN® UNIVERSEL

CONTENU DU KIT

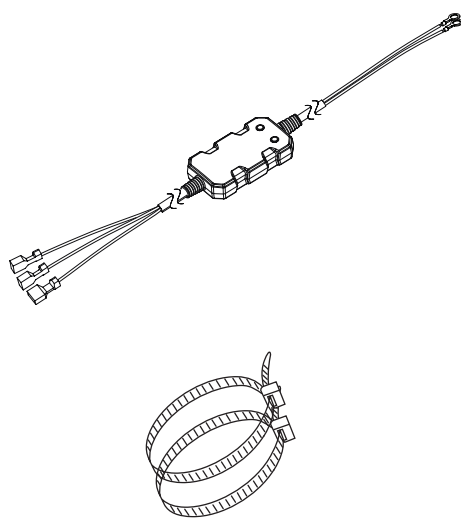

AVANT QUE TU COMMENCES

1.

Télécharger l'application HUB WARN® (application HUB) sur l'App Store ou Google Play.

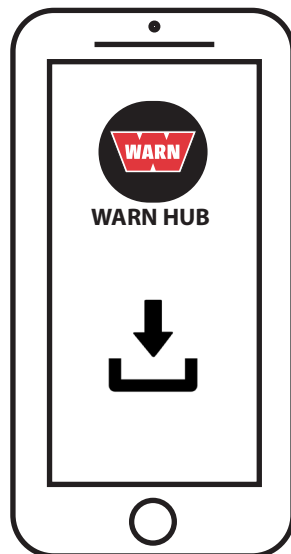

Les frais habituels de messagerie SMS et de transmission de données s'appliquent.
Apple est une marque de commerce d'Apple Inc., déposée aux États-Unis et dans d'autres pays. L'App Store est une marque de service d'Apple Inc.
Google Play est une marque de commerce de Google Inc.

MONTER



2.

Déterminer la position de montage et le cheminement des câbles.

Recommandation : Sous le capot du véhicule, sur le châssis du véhicule ou le long des autres faisceaux de câbles. Éviter les bords tranchants, les sources de chaleur et les pièces mobiles.

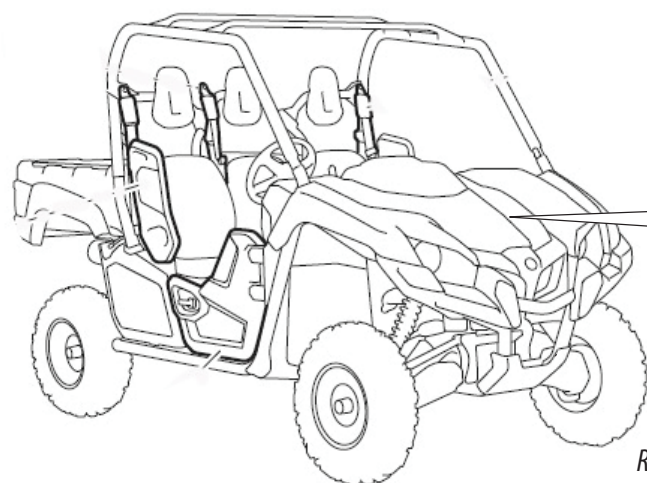

3.

Au moyen des serre-câbles fournis, monter le récepteur HUB fermement sur le véhicule.

4.

Acheminez les extrémités des cosses du récepteur HUB vers le bloc de commande / contacteur du treuil. **REMARQUE :** veiller à acheminer les câbles en évitant les bords tranchants, les sources de chaleur et les pièces mobiles.

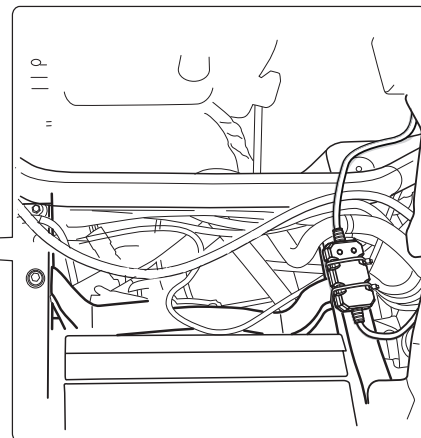

REMARQUE : fixer les câbles sur le véhicule au moyen des serre-câbles à intervalles réguliers afin qu'ils soient sécurisés et restent à leur place.



Guide de démarrage rapide

RÉCEPTEUR HUB WARN® UNIVERSEL

INSTALLER

5. **AVERTISSEMENT** Tous les travaux avec des fils et des câbles électriques doivent être exécutés avec la batterie du véhicule débranchée.

- Couper l'alimentation du véhicule.
- Connecter les fils des cosses à fourche du récepteur HUB sur les connecteurs à fourche du contacteur*.
- Connecter le fil rouge du récepteur HUB au fil de présence de la clé de contact.
- Connecter le fil noir à la terre du véhicule.
- Reconnecter l'alimentation du véhicule.

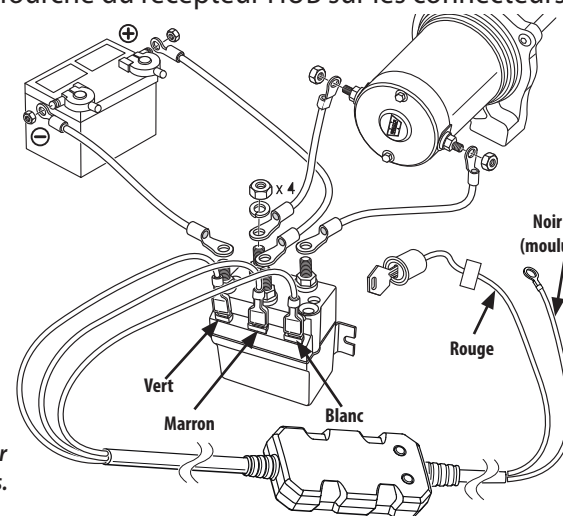

* L'illustration représente le câblage d'un contacteur Powersports. Pour les treuils dotés d'un coffret de commande, la couleur des cosses à fourche peut être différente. Voir le manuel du propriétaire pour en savoir plus.

PUISSANCE

6.

Mettre le véhicule en marche.

REMARQUE : le récepteur HUB est activé si le voyant jaune est allumé.

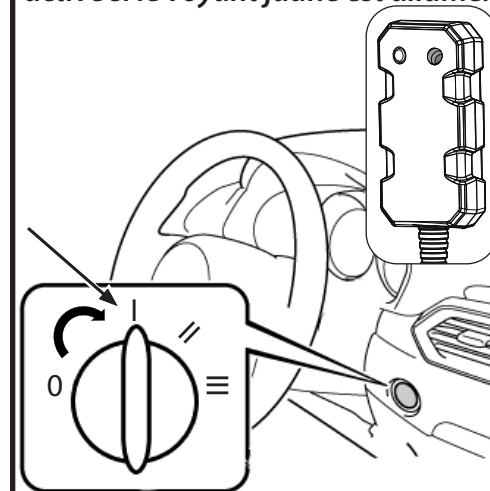

APPARIER/RELIER

7.

Appuyer sur le bouton du récepteur HUB jusqu'à ce que voyant bleu clignote (environ 2 secondes) et relâcher.

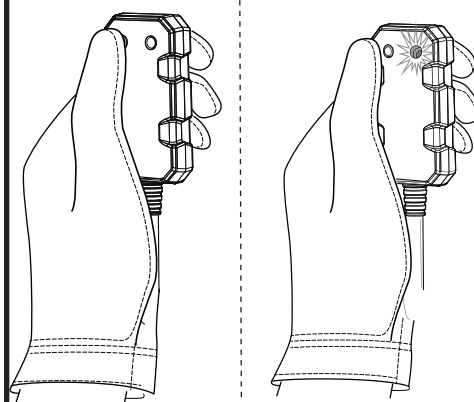

8.

Ouvrir l'application sur le téléphone et suivre les consignes.

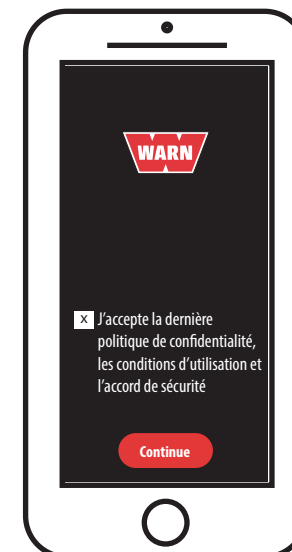

9.

Lorsque le voyant du récepteur HUB devient vert, la connexion est établie. Continuer à suivre les consignes de l'application.

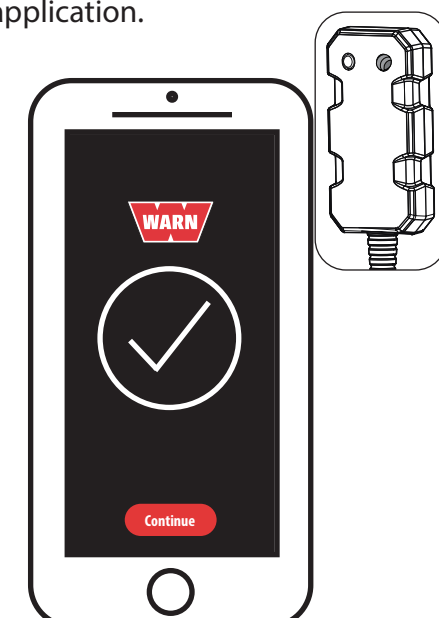

SERVICE CLIENTS

WARN INDUSTRIES, INC. 12900 S.E. Capps Road,
Clackamas, OR États-Unis 97015-8903, 1-503-722-1200
Service à la clientèle: 1-800-543-9276
Le Service de Locateur de négociant: 1-800-910-1122
www.warn.com



Guía de inicio rápido

RECEPTOR UNIVERSAL WARN® HUB

CONTENIDO DEL KIT

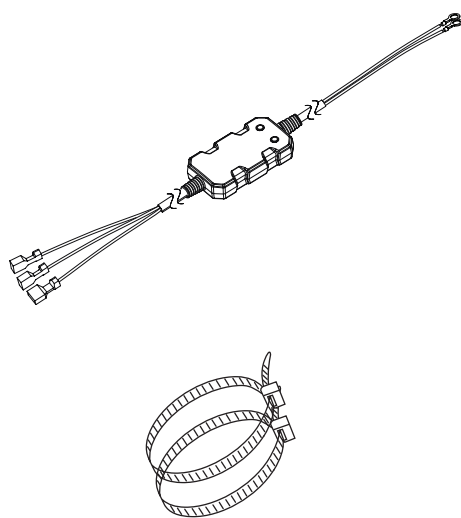

ANTES DE QUE EMPIECES

1.

Descargue la aplicación WARN® HUB (aplicación HUB) en la App Store o en Google Play.

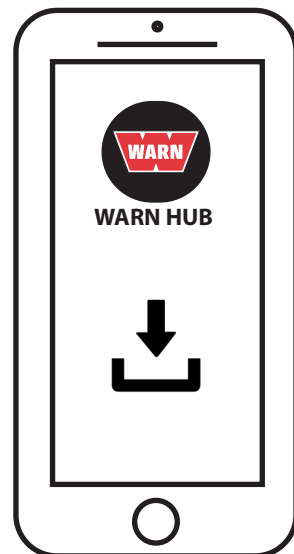

Pueden aplicarse tarifas de mensajes y datos
Apple es una marca comercial de Apple Inc. registrada en EE. UU. y otros países. App Store es una marca de servicio de Apple Inc.
Google Play es una marca comercial de Google Inc

MONTAR



2.

Determine la ubicación de montaje y la ruta de enrutamiento de los cables.

Recomendación: Debajo del capó del vehículo, en el bastidor del vehículo o a lo largo de otros haces de cables. Evite los bordes afilados, el calor y las piezas móviles. **Recommendation:**

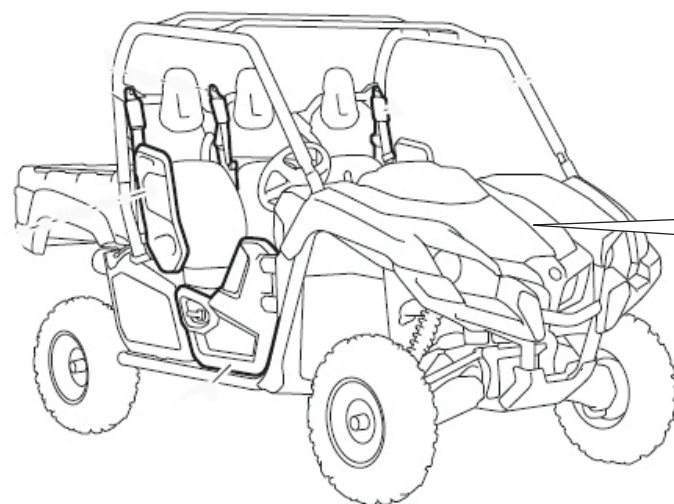

3.

Con las bridas incluidas, monte el receptor HUB en el vehículo con firmeza.

4.

Dirija los extremos del terminal de pala del receptor HUB al paquete de control del cabrestante / contactor. **NOTA:** Asegúrese de mantener los cables alejados de bordes afilados, calor y piezas móviles.

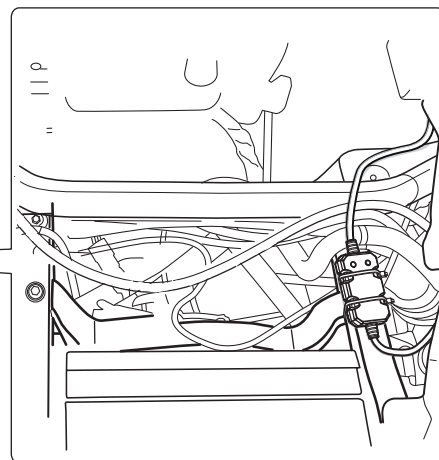

NOTA: Fije los cables al vehículo con una brida en intervalos regulares para mantenerlos seguros y bien posicionados.



Guía de inicio rápido

RECEPTOR UNIVERSAL WARN® HUB

ALAMBRAR

5.

ATENCIÓN Todos los trabajos con cables eléctricos deben realizarse con la batería totalmente desconectada del cableado del vehículo.

- Desconecte la batería del vehículo.
- Conecte los cables de las terminales de horquilla del receptor HUB a los conectores de horquilla del contactor*.
- Conecte el cable rojo del receptor HUB al cable de ignición con llave.
- Conecte el cable negro a la toma de tierra del vehículo.
- Vuelva a conectar la batería del vehículo.

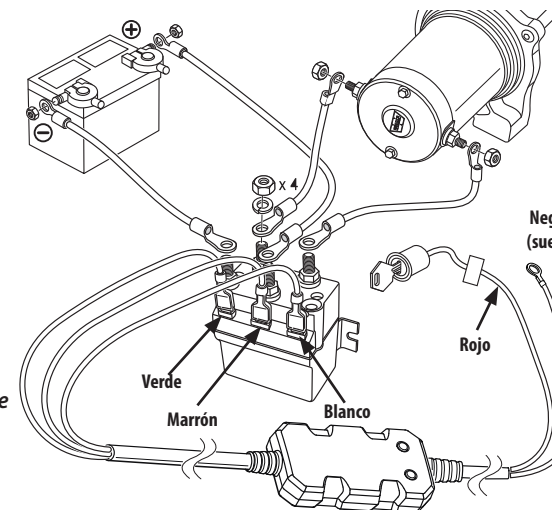

* La ilustración muestra el cableado de un contactor deportivo. En los cabestrantes que cuentan con una caja de control, los colores de la terminal de horquilla pueden cambiar. Consulte el manual del propietario para obtener más información.

ENERGÍA

6.

Encienda la batería del vehículo.

NOTA: Si aparece una luz amarilla, el receptor HUB está activo.

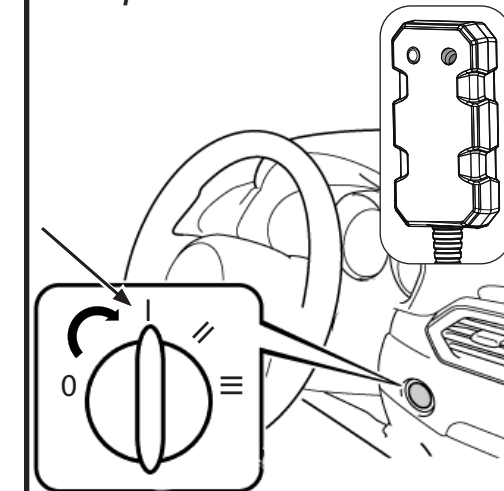

EMPAREJAR/CONECTAR

7.

Mantenga pulsado el botón del receptor HUB solo hasta que la luz azul parpadee (2 segundos aproximadamente) y luego suéltelo.

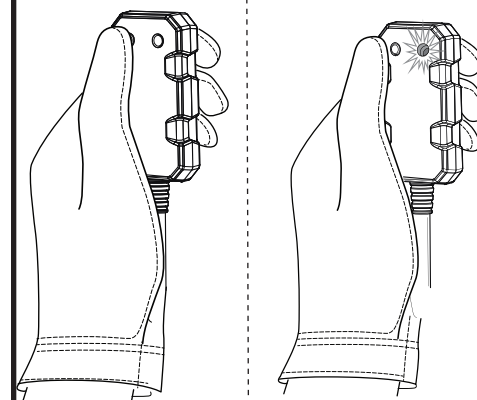

8.

Abra la aplicación en el teléfono y siga las instrucciones.



9.

Cuando la luz del receptor HUB cambie a verde significará que está conectado.

Continúe siguiendo las instrucciones a través de la aplicación.

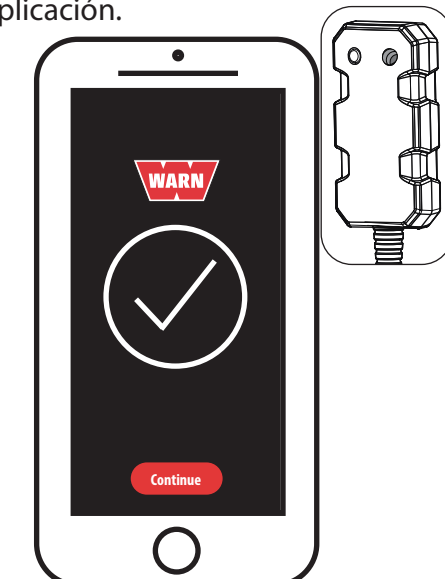

SERVICIO AL CLIENTE

WARN INDUSTRIES, INC. 12900 S.E. Capps Road,
Clackamas, OR EE.UU. 97015-8903, 1-503-722-1200
Servicio de atención al cliente: 1-800-543-9276
Servicio de Localizador de comerciante: 1-800-910-1122
www.warn.com



Kurzanleitung

WARN® HUB-UNIVERSALEMPFÄNGER



Kurzanleitung

WARN® HUB-UNIVERSALEMPFÄNGER

KIT INHALT

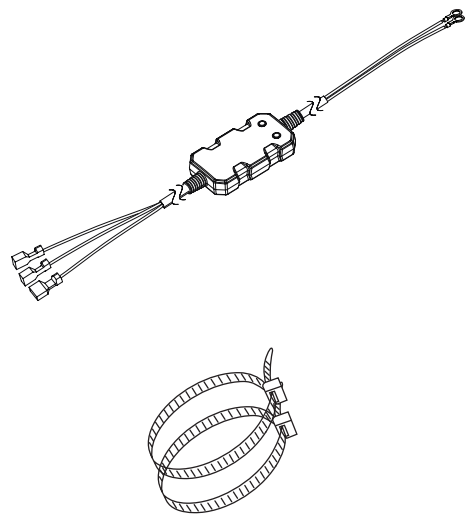

BEVOR SIE BEGINNEN

1.

Laden Sie die WARN® HUB App (HUB App) aus dem App Store oder aus Google Play herunter.

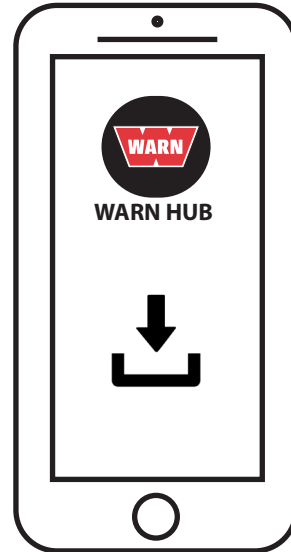

Es können SMS- und Datenübertragungsgebühren anfallen.
Apple ist eine Marke von Apple Inc., eingetragen in den USA und in anderen Ländern. App Store ist eine Dienstleistungsmarke von Apple Inc.
Google Play ist eine Marke von Google Inc.

MONTIEREN



2.

Bestimmen Sie die Montagestelle und eine Route für die Kabelverlegung.

Empfehlung: unter der Motorhaube des Fahrzeugs, an der Fahrzeugkarosserie oder entlang anderer Kabelstränge. Meiden Sie scharfe Kanten, Hitze und bewegliche Teile.

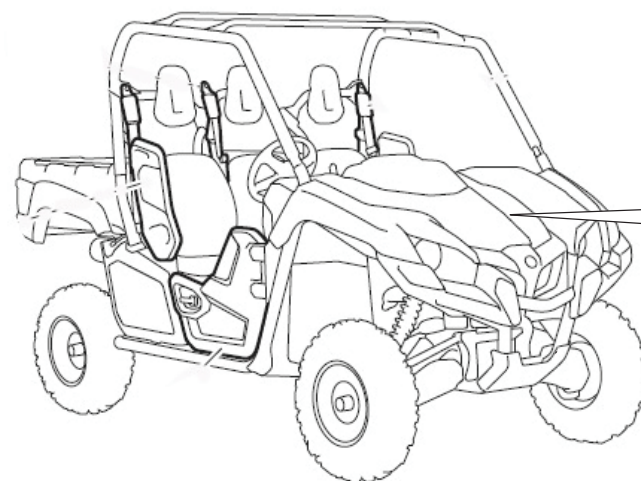

3.

Befestigen Sie den HUB-Empfänger mit den mitgelieferten Kabelbindern sicher am Fahrzeug.

4.

Führen Sie die Flachsteckerenden des HUB-Empfängers zum Windensteuergerät / Schütz. **HINWEIS:** achten Sie darauf, Drähte/Kabel von scharfen Kanten, Hitze und beweglichen Teilen fernzuhalten.

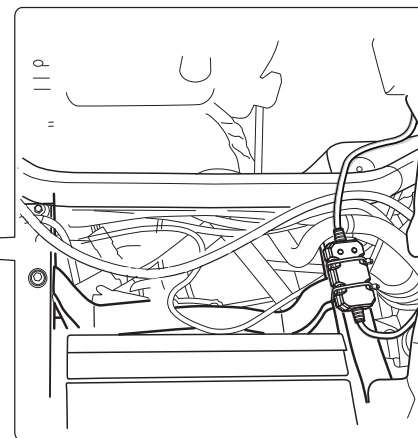

HINWEIS: bringen Sie in regelmäßigen Abständen Kabelbinder am Fahrzeug an, um die Kabel zu sichern.

VERDRAHTEN

5. **ACHTUNG** Sämtliche Arbeiten mit Elektrodrähten und -kabeln sind bei vollständig von der Fahrzeugverkabelung getrennter Batterie durchzuführen.

- Trennen Sie das Fahrzeug von der Stromversorgung.
- Verbinden Sie die Flachstecker der Kabel des HUB-Empfängers mit den Schaltschützanschlüssen*.
- Verbinden Sie das rote Kabel des HUB-Empfängers mit dem Zündungskabel.
- Verbinden Sie das schwarze Kabel mit der Fahrzeugmasse.
- Schließen Sie die Stromversorgung des Fahrzeugs wieder an.

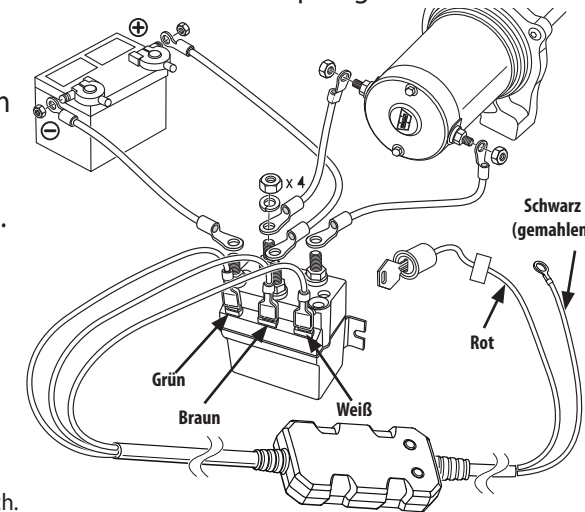

* Die Abbildung zeigt die Verkabelung mit einem Powersports Schaltschütz. Bei Winden mit Steuerung können die Farben der Anschlüsse abweichen. Einzelheiten entnehmen Sie bitte dem Benutzerhandbuch.

LEISTUNG

6.

Schalten Sie die Stromversorgung des Fahrzeugs ein.

HINWEIS: die gelbe Leuchte zeigt an, dass der HUB-Empfänger aktiv ist.

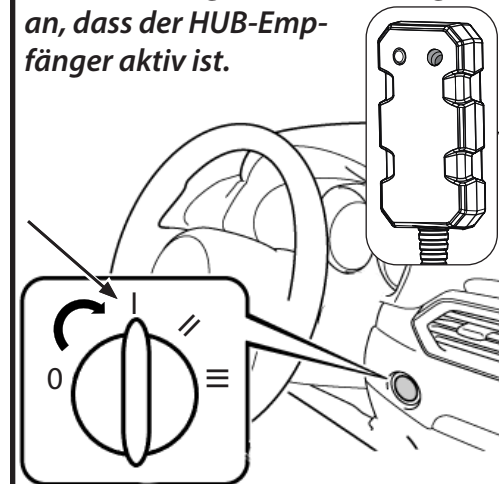

PAAR/VERBINDEN

7.

Halten Sie die Taste am HUB-Empfänger gedrückt, bis die Leuchte blau blinkt (ungefähr zwei Sekunden). Lassen Sie die Taste dann los.

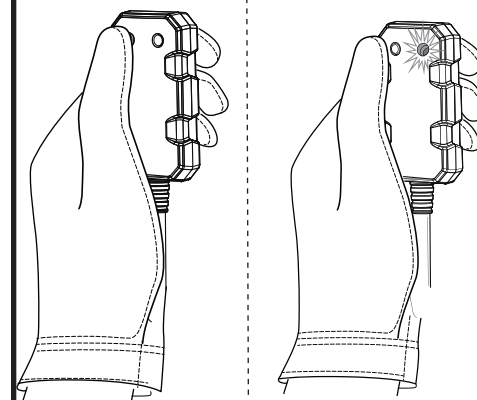

8.

Öffnen Sie die App auf dem Smartphone und befolgen Sie die Anweisungen.

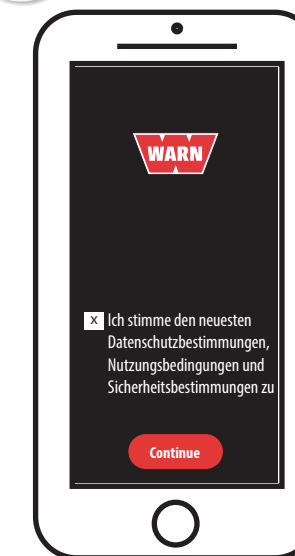

9.

Wenn die Leuchtanzeige am HUB-Empfänger grün wird, sind Sie verbunden.

Befolgen Sie weiter die Anweisungen in Ihrer App.

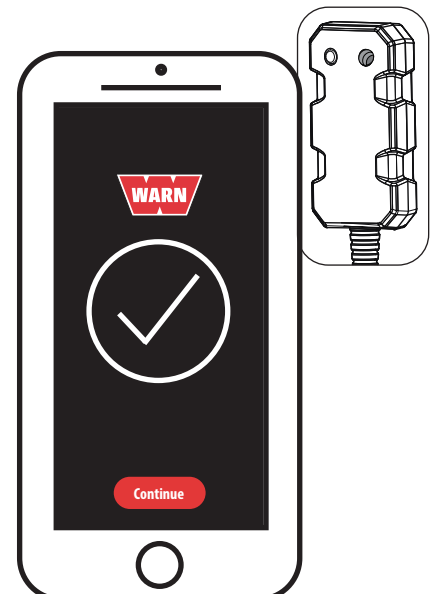

KUNDENDIENST

WARN INDUSTRIES, INC. 12900 S.E. Capps Rd.,
Clackamas, OR USA 97015-8903, 1-503-722-1200
Kundendienst: 1-800-543-9276
Händlersuche: 1-800-910-1122
www.warn.com



Snabbstartsguide

UNIVERSAL WARN® HUB-MOTTAGARE

KIT INNEHÅLL

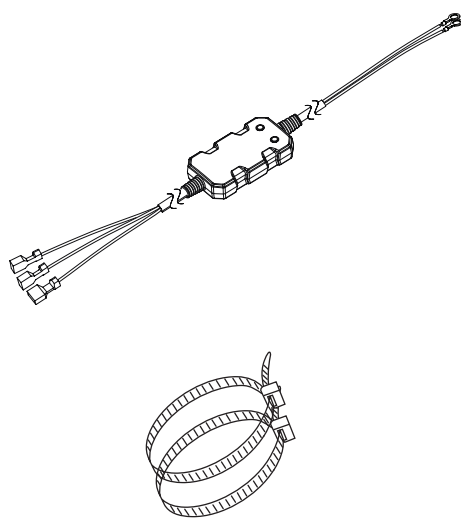

INNAN DU BÖRJAR

1.

Ladda ner WARN® HUB-appen (HUB-ap-
pen) från App Store eller Google Play.

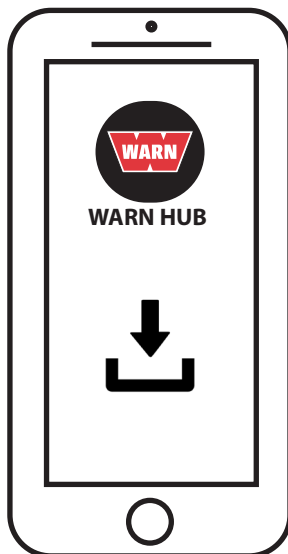

Meddelande- och dataavgifter kan tillkomma
Apple är ett varumärke som tillhör Apple Inc., registrerat i USA och i andra länder. App
Store är ett servicemärke som tillhör Apple Inc.
Google Play är ett varumärke som tillhör Google Inc.

MONTERA



2.

Bestäm monteringsplats och ledningsväg.

Rekommendation: Under fordonshuven, på
fordonsramen eller längs andra kabelförpackningar.
Undvik vassa kanter, värme och rörliga delar.

3.

Använd de medföljande buntbanden och montera
HUB-mottagaren ordentligt på fordonet.

4.

Rutt spadterminaländarna på HUB-mottagaren till vin-
schkontrollpaketet / kontaktorn. **OBSERVERA:** Se till att
leda ledningar/kablar bort från vassa kanter, värme och
rörliga delar.

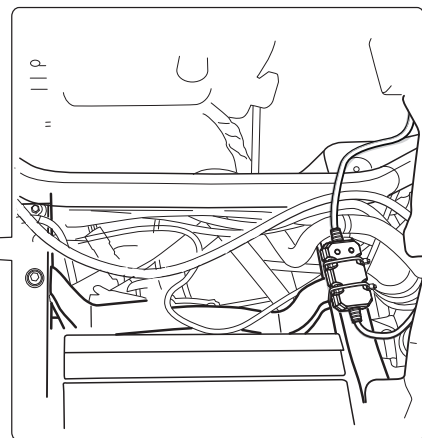
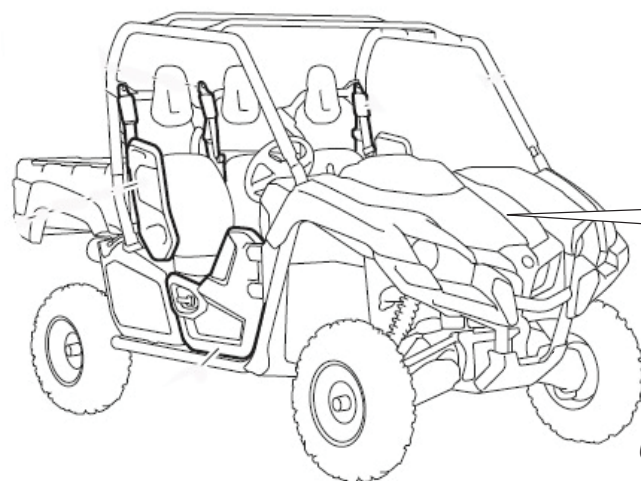

OBSERVERA: Använd buntband för att fästa kablarna till fordonet med jämna
mellanrum för att hålla kablarna säkra och på plats.



Snabbstartsguide

UNIVERSAL WARN® HUB-MOTTAGARE

TRÅD

5.

⚠ VARNING Allt arbete med elektriska ledningar och kablar måste genomföras med batteriet helt
bortkopplat från fordonets kablage.

- Koppla bort fordonets ström.
- Anslut HUB-mottagarens kabelskoledningar till kontaktorns
kabelskokontakter*.
- Anslut HUB-mottagarens
röda ledning till
tändningsledningen.
- Anslut den svarta ledningen
till fordonets jord.
- Anslut fordonets ström igen.

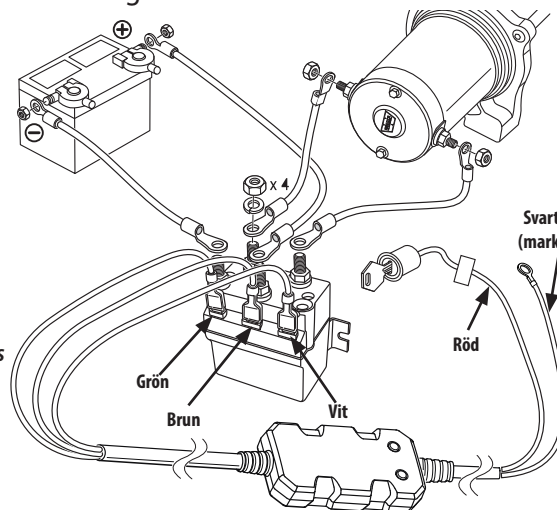

* Illustrationen visar koppling av en
powersports-kontaktor. Kabelskoterminalens
färg kan skilja sig åt när det gäller vinschar
med en kontrollenhet. Se bruksanvisningen
för mer information.

EFFEKT

6.

Slå på fordonets ström.

OBSERVERA: HUB-mottagaren är
aktiv när den gula lampan lyser.

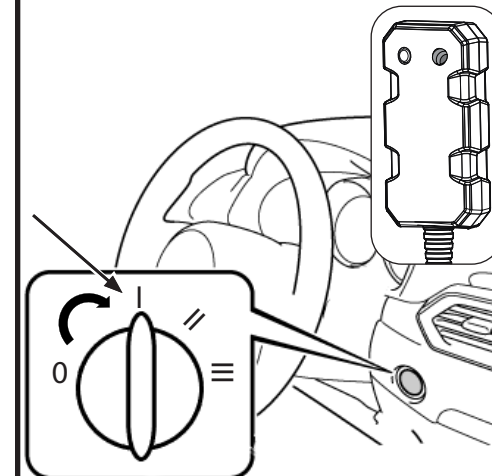

PARA/ANSLUTA

7.

Tryck ned knappen på HUB-
mottagaren tills den blå lampan
blinker (cirka 2 sekunder) och släpp
sedan knappen.

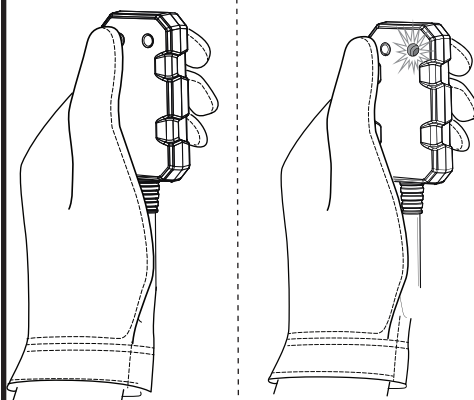

8.

Öppna appen på telefonen och följ
anvisningarna.



9.

När lampan på HUB-mottagaren
blir grön är du ansluten.

Fortsätt följa instruktionerna
genom din app.

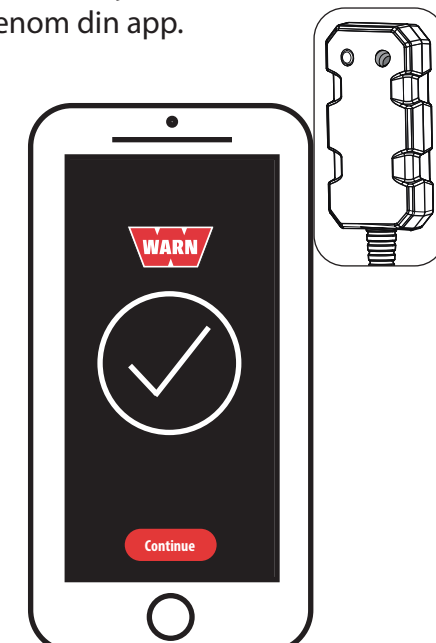

KUNDSERVICE

WARN INDUSTRIES, INC. 12900 S.E. Capps Road,
Clackamas, OR USA 97015-8903, 1-503-722-1200
Kundtjänst: 1-800-543-9276
Återförsäljare: 1-800-910-1122
www.warn.com



Guida di avvio rapido

RICEVITORE HUB WARN® UNIVERSALE

CONTENUTO DEL KIT

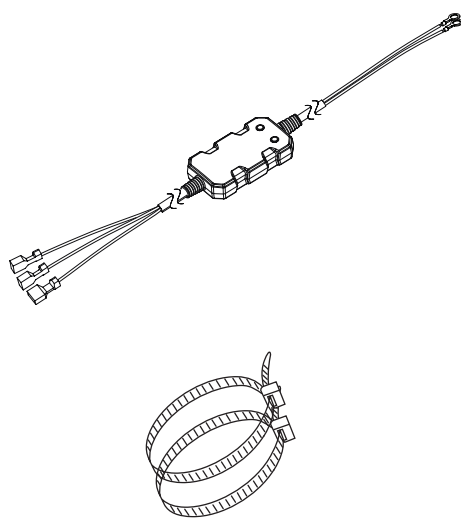

PRIMA DI INIZIARE

1.

Scaricare l'app HUB WARN® (app HUB) da App Store o Google Play.

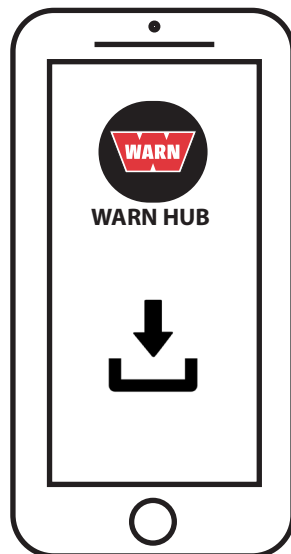

Potrebbero essere applicate tariffe per dati e messaggi
Apple è un marchio di fabbrica di Apple Inc., registrato negli Stati Uniti e in altri paesi. App Store è un marchio di servizio di Apple Inc.
Google Play è un marchio di fabbrica di Google Inc.

MONTARE



2.

Stabilire la posizione di installazione e il percorso di instradamento del cavo.

Consiglio: sotto il cofano del veicolo, sul telaio del veicolo o lungo altri fasci di cavi. Evitare spigoli vivi, fonti di calore e parti in movimento.

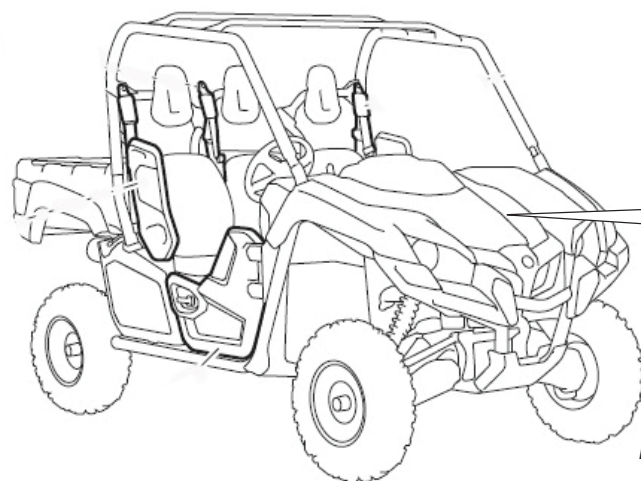

3.

Utilizzando le fascette in dotazione, fissare saldamente il ricevitore HUB al veicolo.

4.

Instradare le estremità dei terminali a forcella del ricevitore HUB al control pack / contattore del verricello.
NOTA: assicurarsi di tenere lontani i conduttori e i cavi da spigoli vivi, fonti di calore e parti in movimento.

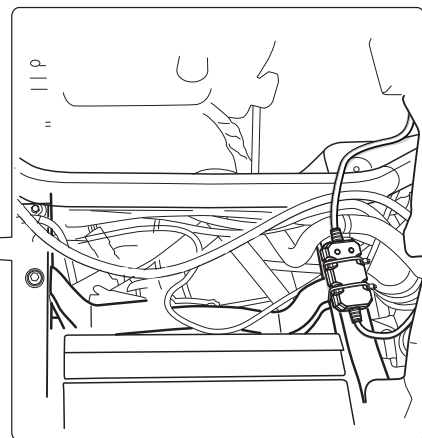

NOTA: fissare con le fascette i cavi al veicolo a intervalli regolari per mantenerli saldamente in sede.



Guida di avvio rapido

RICEVITORE HUB WARN® UNIVERSALE

CABLARE

5. **AVVERTENZA** Ogni fase di lavoro che richiede l'utilizzo di cavi e conduttori elettrici deve essere eseguita con la batteria completamente scollegata dai fili del veicolo.

- Scollegare l'alimentazione del veicolo.
- Collegare i cavi con terminale a forcella del ricevitore HUB ai connettori a forcella del contattore*.
- Collegare il cavo rosso del ricevitore HUB al cavo del blocchetto di accensione.
- Collegare il cavo nero alla messa a terra del veicolo.
- Ricollegare l'alimentazione del veicolo.

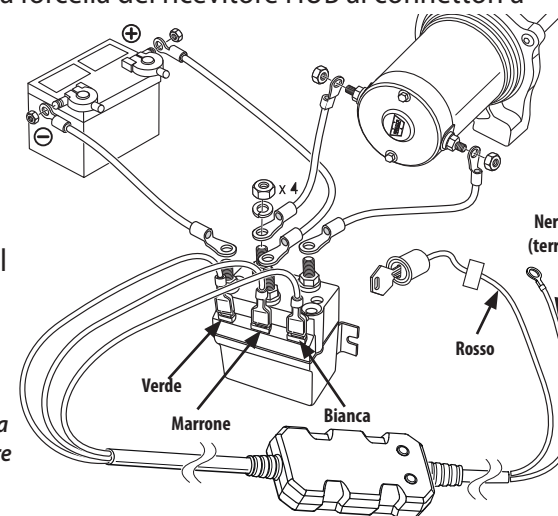

* La figura rappresenta il cablaggio di un contattore Powersports. Nei verricelli dotati di modulo di comando, i colori dei terminali a forcella potrebbero essere diversi. Consultare il manuale utente per maggiori dettagli.

6.

Accendere l'alimentazione del veicolo.

NOTA: il ricevitore HUB è attivo quando la spia gialla è accesa.

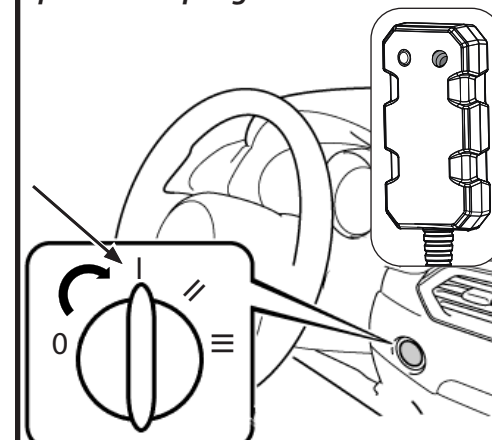

ACCOPIARE/COLLEGARE

7.

Premere e tenere premuto il tasto sul ricevitore HUB finché la spia blu non lampeggia (circa 2 secondi), poi rilasciarlo.

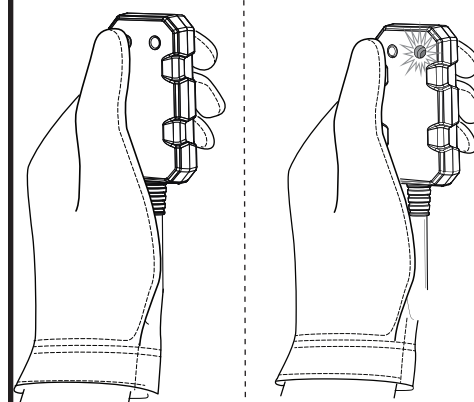

8.

Aprire l'app sul telefono e seguire le istruzioni.



9.

Quando la spia sul ricevitore HUB diventa verde, la connessione è attiva.

Continuare a seguire le istruzioni dell'app.

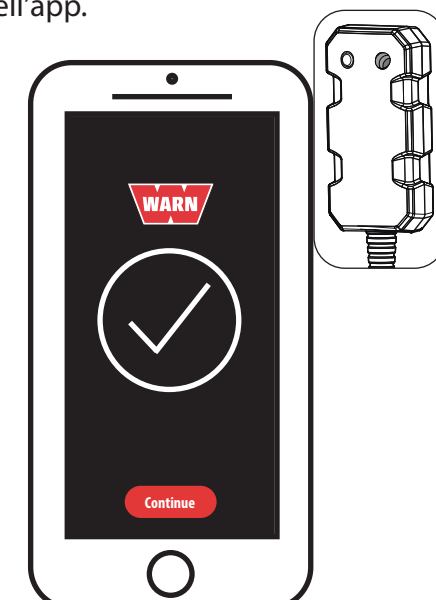

ASSISTENZA CLIENTI

WARN INDUSTRIES, INC. 12900 S.E. Capps Road,
Clackamas, OR USA 97015-8903, 1-503-722-1200
Servizio clienti: 1-800-543-9276
Servizio di localizzazione dei rivenditori: 1-800-910-1122
www.warn.com



Guia rápido

RECEPTOR HUB UNIVERSAL WARN®

CONTEÚDO DO KIT

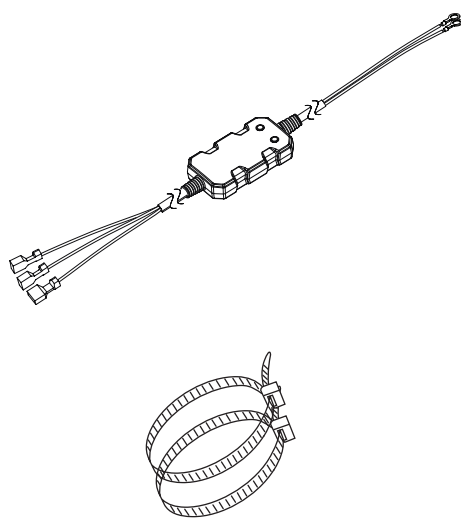

ANTES DE VOCÊ COMEÇAR

1.

Faça o download do aplicativo HUB WARN® (Aplicativo HUB) da App Store ou do Google Play.

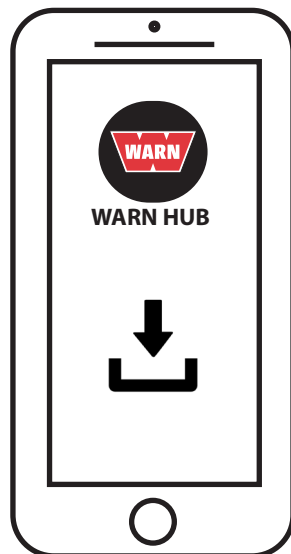

Podem ser aplicadas taxas de mensagens e dados
Apple é uma marca registrada da Apple Inc., nos EUA e em outros países. App Store é uma marca de serviço da Apple Inc.
Google Play é uma marca registrada da Google Inc.

MOUNT



2.

Determine o local de montagem e o encaminhamento do cabo.

Recomendação: embaixo do capô, no chassi do veículo ou em outra fiação. Evite pontas afiadas, calor e peças móveis.

3.

Usando as abraçadeiras incluídas, monte firmemente o receptor HUB ao veículo.

4.

Encaminhe as extremidades do terminal de pá do receptor HUB até o contator / pacote de controle do guincho. **OBSERVAÇÃO:** certifique-se de encaminhar os fios/cabos longe de pontas afiadas, calor e peças móveis.

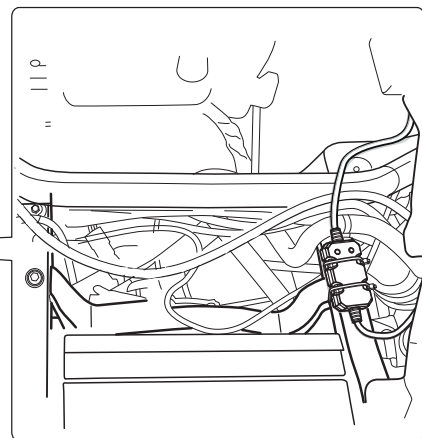
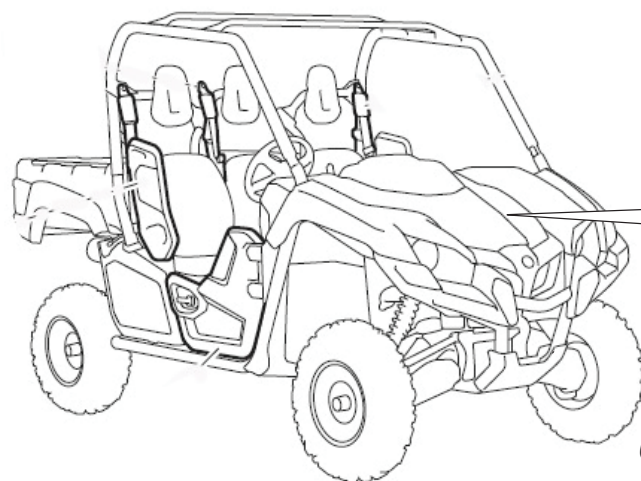

OBSERVAÇÃO: prenda os cabos ao veículo com as abraçadeiras em intervalos regulares, para mantê-los seguros e no lugar.



Guia rápido

RECEPTOR HUB UNIVERSAL WARN®

FIO

5. **ADVERTÊNCIA** Todo trabalho com fios e cabos elétricos deve ser feito com a bateria completamente desconectada da fiação do veículo.

- Desconecte a alimentação do veículo.
- Conecte os cabos com terminais espada do receptor HUB aos conectores espada do contator*.
- Conecte o cabo vermelho do receptor HUB ao cabo de ignição com chave.
- Conecte o cabo preto ao chão do veículo.
- Conecte novamente o veículo.

* A ilustração exibe a fiação de um contator powersports. Para guinchos com pacote de controle, as cores dos terminais espada podem variar. Consulte o manual do proprietário para maiores informações.

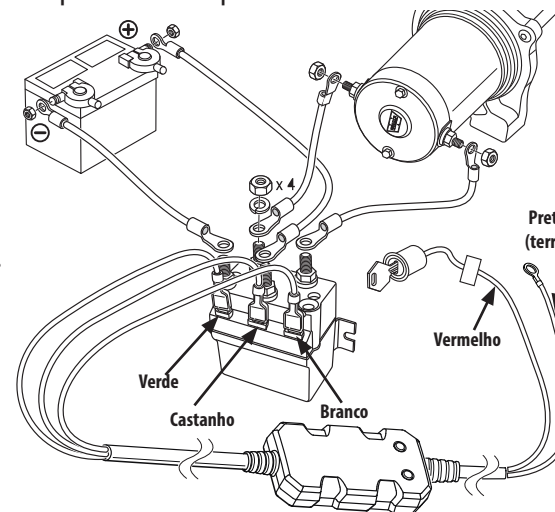

VIGOR

6.

Ligue o veículo.

OBSERVAÇÃO: O receptor HUB está ativo quando a luz amarela está acesa.

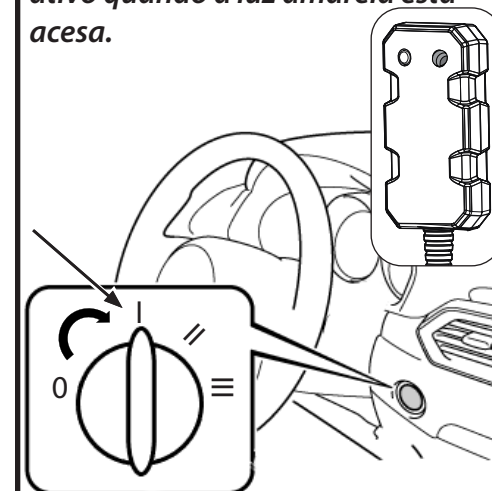

ACASALAR/CONECTAR

7.

Pressione e segure o botão no receptor HUB até que a luz azul pisque (aproximadamente dois segundos) e depois solte.

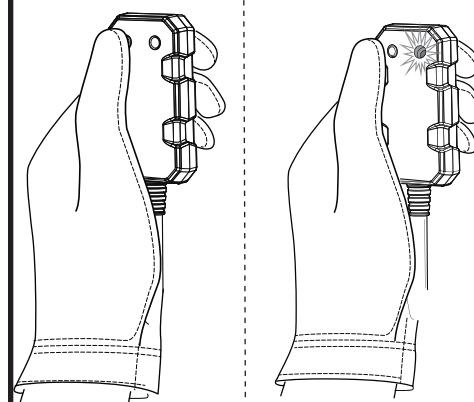

8.

Abra o aplicativo no telefone e siga as instruções.



9.

Quando a luz no receptor HUB fica verde, significa que está conectado. Siga as instruções no aplicativo.

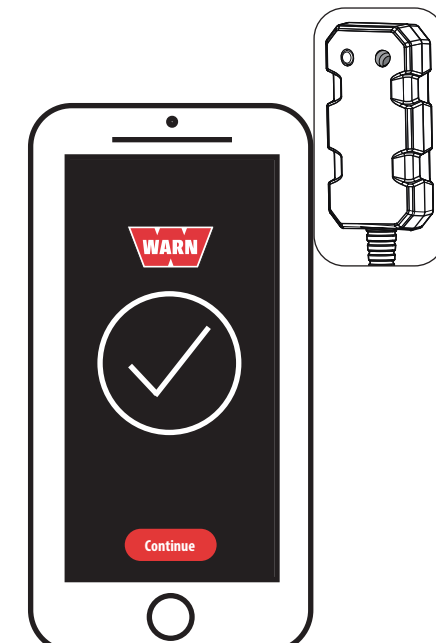

SERVIÇO AO CLIENTE

WARN INDUSTRIES, INC. 12900 S.E. Capps Road,
Clackamas, OU EUA 97015-8903, 1-503-722-1200
Serviço ao Cliente: 1-800-543-9276
Serviço de Localizador de Revendedores: 1-800-910-1122
www.warn.com



Pikaopas

UNIVERSAL WARN® HUB -VASTAANOTIN

PAKKAUKSEN SISÄLTÖ

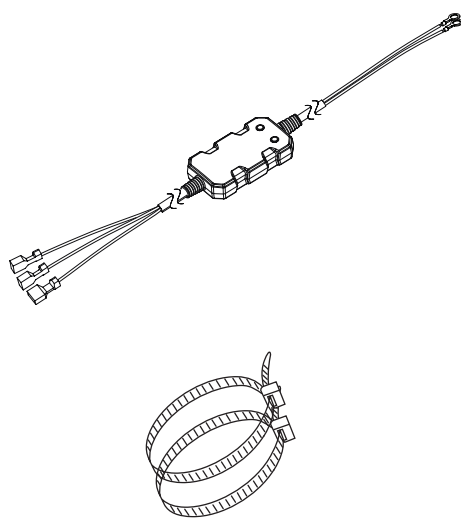

ENNEN KUIN ALOITAT

1.

Lataa WARN® HUB -sovellus (HUB-sovellus) App Storesta tai Google Playsta.

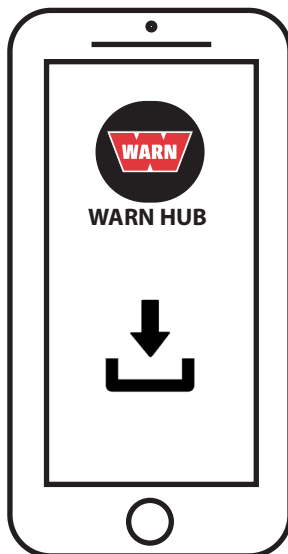

Viestien ja datan hinta saattaa vaihdella.

Apple on Apple Inc:n Yhdysvalloissa ja muissa maissa rekisteröimä tavaramerkki. App Store on Apple Inc:n palvelumerkki.

Google Play on Google Inc:n tavaramerkki.

ASENTAA



2.

Määritä asennuskohta ja johtojen reitti.

Suositus: Ajoneuvon konepellin alle, ajoneuvon koriin tai muiden johdotusten kanssa. Vältä teräviä reunoja, kuumuutta ja liikkuvia osia.

3.

Kiinnitä HUB-vastaanotin mukana toimitetuilla nippusiteillä tukevasti ajoneuvoon.

4.

Reititä HUB-vastaanottimen lapan päätteet vinsin ohjauspakettiin / kontaktoriin. **HUOMAUTUS:** Varmista, että johdot ja kaapelit ohjataan pois päin terävistä reunoista, kuumuudesta ja liikkuvista osista.

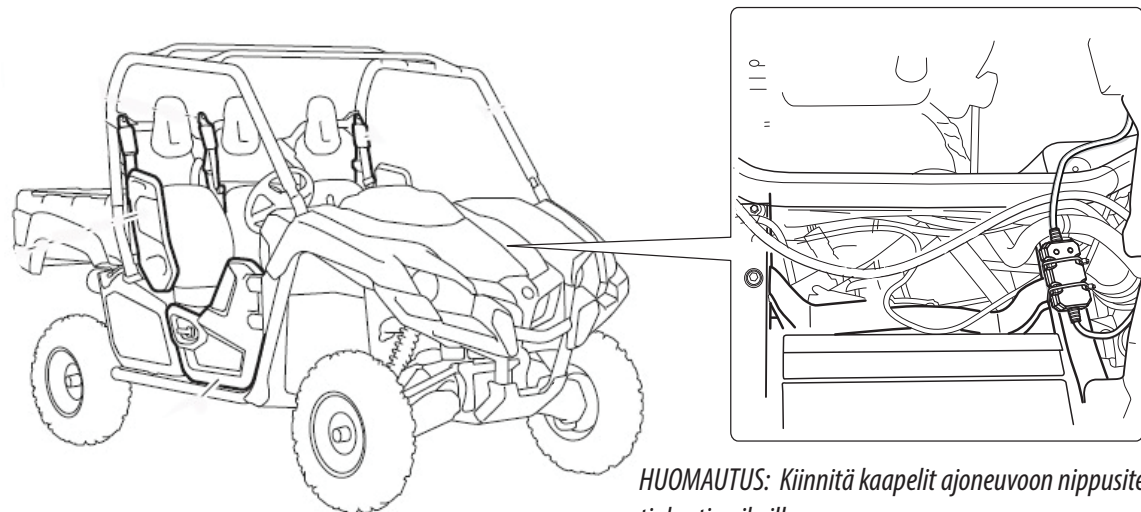

HUOMAUTUS: Kiinnitä kaapelit ajoneuvoon nippusiteillä säännöllisin välein tiukasti paikoilleen.



Pikaopas

UNIVERSAL WARN® HUB -VASTAANOTIN

JOHDOTTA

5.

WAARSCHUWING Alle werkzaamheden aan elektrische bedrading en kabels moeten worden voltooid terwijl de accu volledig is losgekoppeld van de voertuigbedrading.

- Kytke ajoneuvon virta pois päältä.
- Liitä HUB-vastaanottimen haarukkaliittimen johdot koskettimien haarukkaliittimiin*.
- Liitä HUB-vastaanottimen punainen johdin virtalukon sytytysjohtimeen.
- Liitä musta johdin ajoneuvon maadoitukseen.
- Kytke ajoneuvon virta päälle.

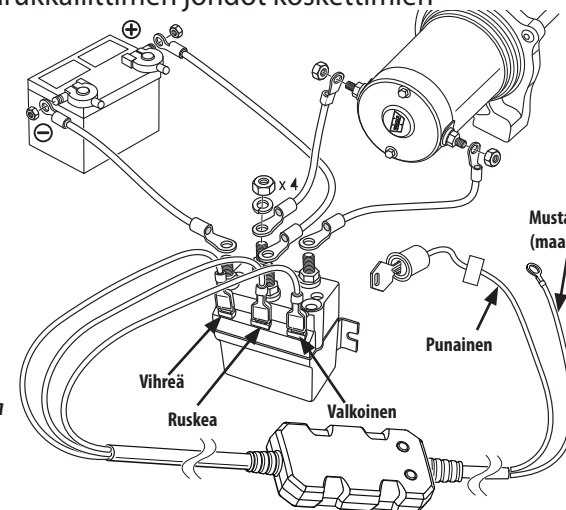

* Kuvassa näkyy powersports-liitin. Haarukkaliittimien värit saattavat vaihdella ohjaussarjan sisältävissä vinsseissä. Katso tiedot omistajan käsikirjasta.

ENERGIA

6.

Käynnistä ajoneuvo. **HUOMAUTUS:** HUB-vastaanotin on aktiivinen, kun keltainen valo palaa.

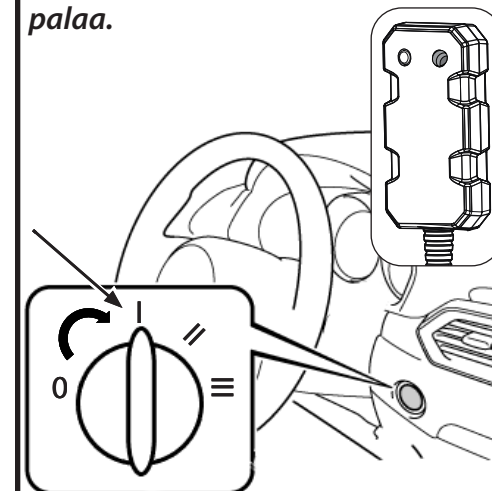

JÄRJESTYÄ PAREITTAIN/LIITTÄÄ YHTEEN

7.

Pitä HUB-vastaanottimen painiketta painettuna, kunnes sininen valo vilkkuu (noin kaksi sekuntia), ja sitten vapauta se.

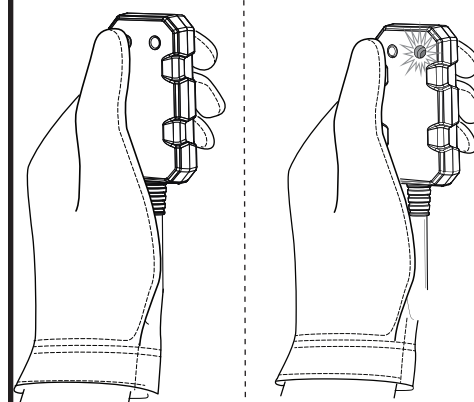

8.

Avaa sovellus puhelimesa ja noudata kehotteita.



9.

Kun HUB-vastaanottimen valo muuttuu vihreäksi, yhteys on muodostettu.

Jatka sovelluksessa esitettyjen ohjeiden mukaisesti.

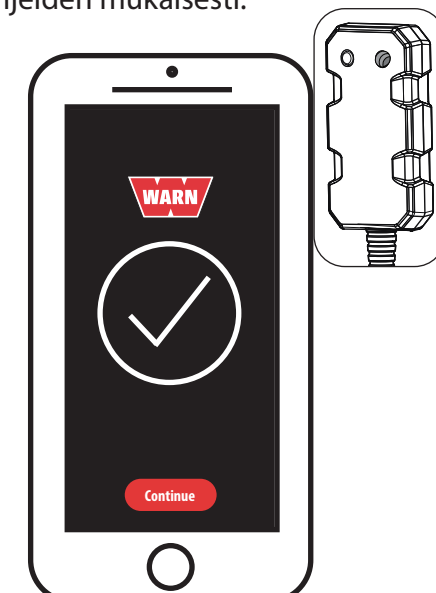

ASIAKASPALVELU

WARN INDUSTRIES, INC. 12900 S.E. Capps Road,
Clackamas, OR USA 97015-8903, 1-503-722-1200
Asiakaspalvelu: 1-800-543-9276
Jälleenmyyjähakupalvelu: 1-800-910-1122
www.warn.com



Snelstartgids

UNIVERSAL WARN® HUB-ONTVANGER

INHOUD VAN DE SET

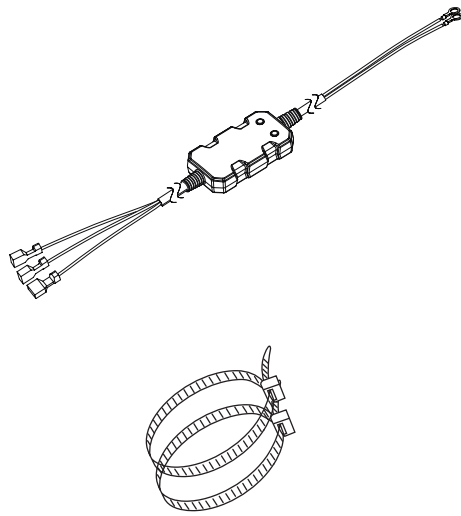

VOORDAT JE BEGINT

1.

Download de WARN® HUB-app (HUB-app) in de App Store of Google Play.

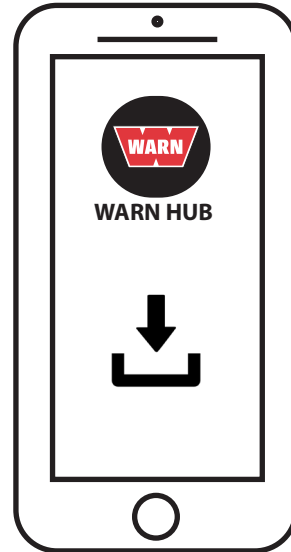

Mogelijk brengt je provider sms- en datakosten in rekening
App Store is een handelsmerk van Apple Inc., gedeponeerd in de VS en andere landen. App Store is een servicemerk van Apple Inc.
Google Play is een handelsmerk van Google Inc.

MONTEREN



2.

Bepaal montageplaats en de route van de bedrading.

Aanbeveling: Onder de voertuigkap, op het frame van het voertuig of naast andere bedradingen. Vermijd scherpe randen, hete en bewegende onderdelen.

3.

Monteer de HUB-ontvanger stevig aan het voertuig met behulp van de meegeleverde kabelbinders.

4.

Leid de uiteinden van de schopaansluitingen van de HUB-ontvanger naar de lierbesturing / magneetschakelaar. **OPMERKING:** Verifieer dat draden/kabels niet worden geleid langs scherpe randen, hitte en bewegende onderdelen.

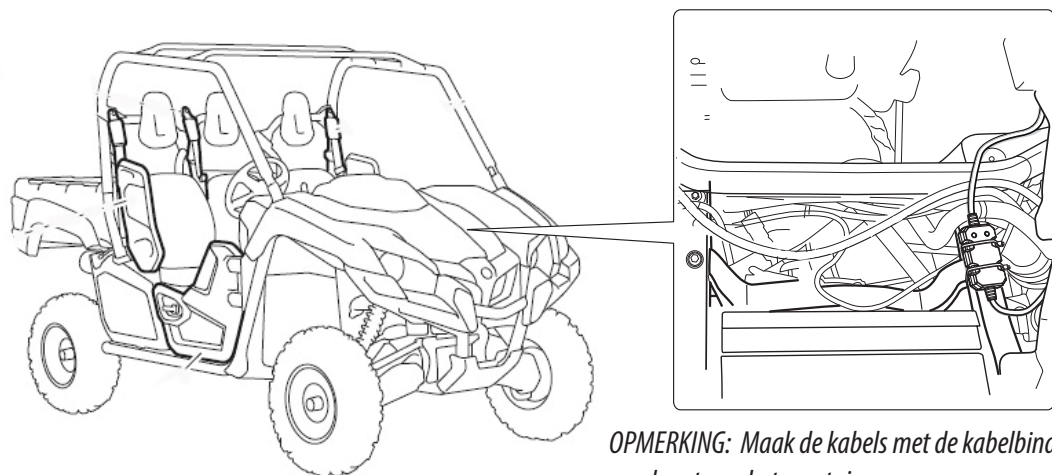

OPMERKING: Maak de kabels met de kabelbinders, op gelijke afstand van elkaar, goed vast aan het voertuig.



Snelstartgids

UNIVERSAL WARN® HUB-ONTVANGER

AAN DRAAD RIJGEN

5. **VAROITUS** Kaikkien sähköjohtoja ja kaapeleita koskevien töiden aikana akun on oltava kokonaan irti ajoneuvon kytkennöistä.

- Schakel voertuigvermogen uit.
- Verbind de steekaansluitingen van de HUB-ontvanger met de steekverbindingen van de schakelaar*.
- Verbind de rode draad van de HUB-ontvanger met de contactsleuteldraad.
- Verbind de zwarte draad met de voertuigaarding.
- Schakel het voertuigvermogen weer in.

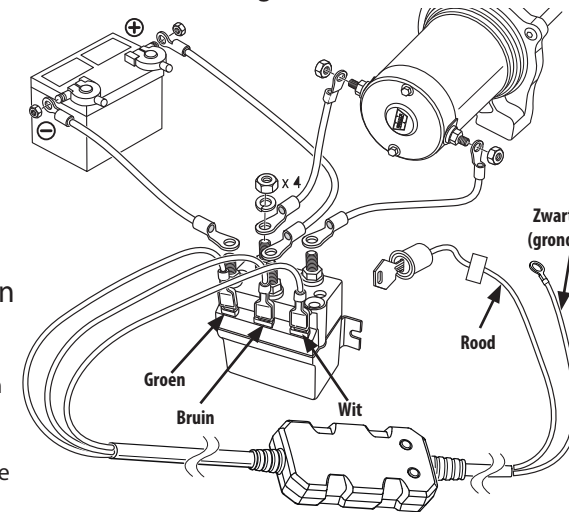

* Illustratie geeft bedrading weer van een motorsportschakelaar. Voor lieren met een bedieningspakket kunnen de kleuren van de steekaansluiting anders zijn. Zie de handleiding voor details.

MOGENDHEID

6.

Schakel het voertuigvermogen in. **OPMERKING:** De HUB-ontvanger is actief wanneer het gele lampje brandt.

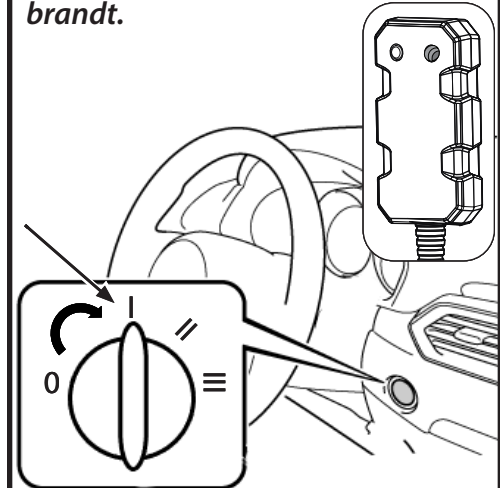

PAAR-/AANSLUITEN

7.

Houd de knop op de HUB-ontvanger ingedrukt totdat het blauwe lampje knippert (ongeveer 2 seconden), laat dan los.

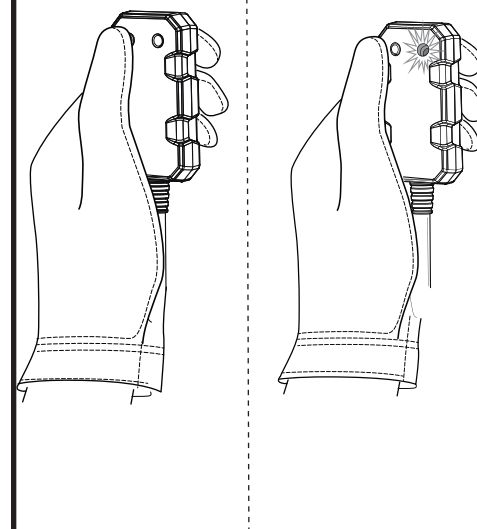

8.

Open de app op de telefoon en volg de aanwijzingen.



9.

Wanneer het lampje op de HUB-ontvanger groen gaat branden, is er verbinding.

Volg de aanwijzingen op de app.

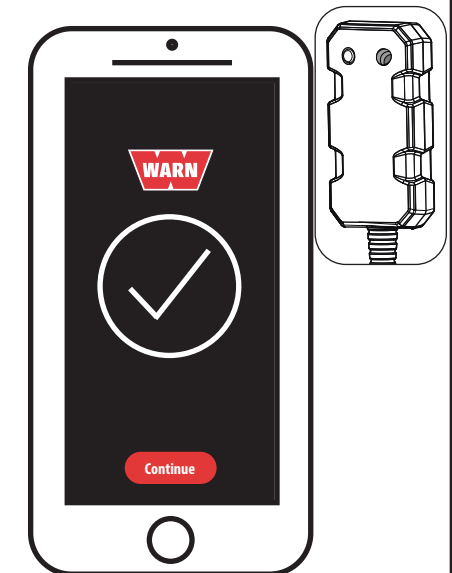

KLANTENSERVICE

WARN INDUSTRIES, INC. 12900 S.E. Capps Road,
Clackamas, OR 97015-8903, 1-503-722-1200
Klantenservice: 1-800-543-9276
Dealerzoekservic: 1-800-910-1122
www.warn.com